

Photo: Carlo Borlenghi

2021 - 2024

Equipment Rules of Sailing

sport / nature / technology

**THE
EQUIPMENT RULES
OF
SAILING**

for 2021-2024

World Sailing

World Sailing has an ambitious wide ranging sustainability strategy safeguarding the future of the sport whilst protecting the waters of the world. This was ratified in May 2018. Sustainability Agenda 2030 can be accessed here:

<https://www.sailing.org/about/Sustainability>

Contact Details for the World Sailing Executive Office:

World Sailing,
20 Eastbone Terrace
London W2 6LG
UK

Tel +44(0)2039 404 888

Email office@sailing.org

www.sailing.org

Published by World Sailing (UK) Ltd., London, UK
© World Sailing Ltd.

CONTENTS

Introduction	4
Part 1 – Use of Equipment	
Section A – During an Event	6
Section B – While Racing	7
Part 2 – Definitions	
Section C – General Definitions	8
Section D – Hull Definitions	13
Section E – Hull Appendage Definitions	14
Section F – Rig Definitions	16
Section G – Sail Definitions	27
Subsection A – Trilateral Sails	27
Subsection B – Additions for Other Sails	38
Part 3 – Rules Governing Equipment Control and Inspection	
Section H – Equipment Control and Inspection	40
Appendix 1	
Racing Rules that govern the use of equipment.....	44
Appendix 2	
Abbreviations for primary sail dimensions	45
Index of Defined Terms	46

INTRODUCTION

The *Equipment Rules of Sailing* includes and references:

- Rules for use of equipment.
- Definitions of equipment, measurement points and measurements for use in **class rules** and other rules and regulations.
- Rules governing **certification control** and **equipment inspection**.

Applicability

The ERS are *rules* only if they are invoked by:

- (a) **Class Rules**.
- (b) Adoption in the notice of race and sailing instructions.
- (c) Prescriptions of an MNA for races under its jurisdiction.
- (d) World Sailing Regulations, or
- (e) Other documents that govern an event.

Terminology

A term used in its defined sense is printed in “**bold**” if defined in the ERS and in “*italic*” if defined in the RRS. The use of an ERS term in its defined sense may also be used in other forms of the word and shall refer to the original defined term. Other words and terms are used in the sense ordinarily understood in nautical or general use in English.

Abbreviations

MNA World Sailing Member National Authority

ICA International Class Association

NCA National Class Association

ERS The Equipment Rules of Sailing

RRS The Racing Rules of Sailing

Revision

The Equipment Rules are revised and published every four years by World Sailing, the international authority for the sport. This edition becomes effective on 1 January 2021 except that for an event beginning in 2020 the date may be postponed by the Notice of Race and Sailing Instructions. Changes to the Equipment Rules are permitted under World Sailing Regulations 29.1.1 and 29.1.2. No changes are contemplated before 2024, but any changes determined to be urgent before then will be announced through National Authorities and posted on the World Sailing website (sailing.org).

INTRODUCTION

Changes

The ERS may only be changed as follows:

- (a) Prescriptions of an MNA may change a rule in ERS Part 1, for races under its jurisdiction.
- (b) **Class rules** may change ERS rules as permitted by rule A.1.

These restrictions do not apply if rules are changed to develop or test proposed rules in local races. The MNA may prescribe that its approval is required for such changes.

| Marginal markings indicate substantial changes to the 2017 – 2020 edition.

PART 1 – USE OF EQUIPMENT

In addition to the rules in Part 1, **class rules** and the *Racing Rules of Sailing* contain rules governing the use of equipment. Appendix 1 provides a list of those racing rules.

Section A – During an Event

A.1 CLASS RULES

Class rules may change rules B.1, B.2 and B.3.

A.2 CERTIFICATE

A.2.1 Having a Certificate

The **boat** shall have such valid **certificate** as required by its **class rules** or the **certification authority**.

A.2.2 Compliance with a Certificate

The **boat** shall comply with its **certificate**.

See also RRS rule 78 Compliance with Class Rules; Certificates.

Section B – While Racing

B.1 POSITION OF EQUIPMENT

B.1.1 Mast Upper Limit Mark

(a) TRILATERAL MAINSAIL

The **sail** shall be below the **mast upper limit mark**.

(b) QUADRILATERAL MAINSAIL

The **throat point** shall be below the **mast upper limit mark**.

B.1.2 Mast Lower Limit Mark

When a **sail** is set on a **main boom**, **foremast boom** or **mizzen boom**, the extension of the upper edge of the **spar** shall intersect the mast **spar** above the **mast lower limit mark**, with the boom **spar** on the mast **spar** centreplane and at 90° to the mast **spar**.

B.1.3 Boom Outer Limit Mark

The **leech** of any **sail** set on a **boom**, extended as necessary, shall intersect the upper edge of the boom **spar** forward of the **boom outer limit mark**.

B.1.4 Bowsprit Outer Limit Mark

The **tack** of any **headsail** set on a **bowsprit** shall be **connected** aft of the **bowsprit outer limit mark**.

B.1.5 Bowsprit Inner Limit Mark

The **bowsprit inner limit mark** shall not be outboard the **hull** when the **bowsprit** is set.

B.2 HEADSAIL BOOMS

The fore end of a **headsail boom** shall be approximately on the **boat** centerplane.

B.3 SPINNAKER STAYSAILS AND MIZZEN STAYSAILS

The **tack** of a spinnaker staysail or **mizzen** staysail shall be inboard the **sheerline**

PART 2 – DEFINITIONS

Section C – General Definitions

C.1 CLASS

C.1.1 Class Authority

The body that governs the class as specified in the **class rules**.

C.2 RULES

C.2.1 Class Rules

The rules that specify:

the **boat** and its use, **certification** and administration.

the **crew**.

personal equipment and its use, **certification** and administration.

portable equipment and its use, **certification** and administration.

any other equipment and its use, **certification** and administration.

changes to the *Racing Rules of Sailing* as permitted by RRS 86.1(c).

The term includes rules of handicap and rating systems.

C.2.2 Closed Class Rules

Class rules where anything not specifically permitted by the **class rules** is prohibited.

C.2.3 Open Class Rules

Class rules where anything not specifically prohibited by the **class rules** is permitted.

C.2.4 Class Rules Authority

The body that provides final approval of the **class rules**, **class rule** changes and **class rule** interpretations.

C.3 CERTIFICATION

C.3.1 Certification Authority

World Sailing, the MNA in the country where the **certification** shall take place, or their delegates.

C.3.2 Certify/Certification

To issue a **certificate**, or apply a **certification mark** after successful **certification control**.

C.3.3 Certificate

Documentary proof of successful **certification control** as required by the **class rules** or a **certification authority**.

For the **hull**: issued by World Sailing, the MNA of the owner, or their delegates.

For other items: issued by the **certification authority**.

The term includes handicap and rating certificates.

C.3.4 Certification Mark

Proof of successful **certification control** of a part requiring **certification** applied as required by the **class rules** or a **certification authority**.

C.4 CERTIFICATION CONTROL AND EQUIPMENT INSPECTION

See H.1 and H.2.

C.4.1 Fundamental Measurement

The methods used as the primary means to establish the physical properties of equipment.

C.4.2 Certification Control

The methods used as means of equipment control required by **class rules**, or a **certification authority**, for **certification**.

C.4.3 Equipment Inspection

Control carried out at an event as required by the notice of race and the sailing instructions which may include **fundamental measurement**.

C.4.4 Official Measurer

A person appointed or recognised, by the MNA of the country where the control takes place, to carry out **certification control** and when the **class rules** permit, **certification**. An MNA may have delegated this responsibility.

C.4.5 In-House Official Measurer

An **official measurer** appointed in accordance with the World Sailing In-House Certification Programme.

C.4.6 Equipment Inspector

A person appointed by a technical committee to carry out **equipment inspection**.

C.4.7 Limit Mark

A clearly visible mark of a single colour, contrasting to the part(s) on which it is placed, indicating a measurement point.

C.4.8 Event Limitation Mark

A mark placed by a technical committee on equipment whose replacement at the event is controlled by the **class rules**.

PART 2 DEFINITIONS

C.5 PERSONAL DEFINITIONS

C.5.1 Crew

A competitor, or team of competitors, that operates a **boat**.

C.5.2 Personal Equipment

All personal effects carried or worn and items worn on board to keep warm and/or dry, and/or to protect the body, **personal flotation device**, safety harnesses and hiking aids worn to keep the person aboard or afloat.

C.5.3 Personal Flotation Device

Personal equipment as required by the *rules* to assist the user to float in water.

C.6 BOAT DEFINITIONS

C.6.1 Boat

The equipment used by the **crew** to take part in a race.

It includes:

hull(s)

structure(s) connecting **hulls**

hull appendage(s)

ballast

rig

sail(s)

fittings

boat **corrector weights** and

all other items of equipment used

but excludes

consumables

personal equipment and

portable equipment.

C.6.2 Boat Types

(a) MONOHULL

A **boat** with one **hull**.

(b) MULTIHULL

A **boat** with more than one **hull**.

(c) WINDSURFER

A **boat**.

(d) KITE-BOARD

A **boat**.

C.6.3 Boat Control Definitions

(a) MAJOR AXES

The three major axes of the boat at 90° to each other – vertical, longitudinal and transverse – shall be related to the baseline and the hull centreplane.

See H.3.

(b) MEASUREMENT TRIM

Trim achieved when two points on the **hull(s)** are at set distances perpendicular to a plane. The plane, the points and distances to be specified in **class rules**.

(c) FLOTATION TRIM

Trim achieved with the **boat** floating in accordance with H.7.1 – Conditions for Weight and Flotation Measurement.

(d) WATERLINE

The line(s) formed by the intersection of the outside of the **hull(s)** and the water surface when the **boat** is floating in **measurement trim**.

(e) WATERPLANE

The plane passing through the **waterline**.

(f) BALLAST

Weight **installed** to influence the stability, flotation or total weight of the **boat**.

Ballast types:

(i) INTERNAL BALLAST

Ballast positioned inside a **hull**.

(ii) EXTERNAL BALLAST

Ballast positioned outside a **hull**.

(iii) MOVEABLE BALLAST

Internal **ballast** or external **ballast** that may be moved.

(iv) VARIABLE BALLAST

Water **ballast** the amount of which may be varied and which may also be moved.

(v) CORRECTOR WEIGHT

Weight **installed** in accordance with the **class rules** to correct deficiency in weight and/or its distribution.

(g) CONNECT

To bring together or into contact so that a real link is established by which one item affects the function of the other; therefore includes “attached to” and “sheeted to” the corner of the **sail**.

C.6.4 Boat Dimensions

(a) BOAT LENGTH

The longitudinal distance between the aftermost point and the foremost point of the **boat**, excluding **sails**, with **spars** set as appropriate.

See H.3.4.

PART 2 DEFINITIONS

- (b) **BOAT BEAM**
The transverse distance between the outermost points of the **boat**.
- (c) **WATERLINE LENGTH**
The longitudinal distance between the aftermost point and the foremost point of the **waterline**.
- (d) **WATERLINE BEAM**
The transverse distance between the outermost points of the **waterline**.
- (e) **DRAFT**
The vertical distance between the **waterplane** and the lowest point of the **boat**.
- (f) **MINIMUM DRAFT**
The **draft** with all **hull appendages** in their highest position.
- (g) **MAXIMUM DRAFT**
The **draft** with all **hull appendages** in their lowest position.
- (h) **BOAT WEIGHT**
The weight of the **boat** excluding **sail(s)** and **variable ballast**.
- (i) **LIST ANGLE**
The maximum angle of heel of the **boat**, measured relative to the **boat** floating upright, in the condition for weight and flotation measurement with **moveable ballast** moved fully to port or starboard.
- (j) **HULL APPENDAGE DEPTH**
The maximum vertical distance between the **hull** shell or a measurement point as specified in the **class rules** and the lowest point of a **hull appendage** in its lowest position.

C.6.5 Boat Age

- (a) **SERIES DATE**
The date on which the first **boat** of the design or the production series was first launched, whichever is earlier. Series Date does not change if the **boat** is modified.
- (b) **AGE DATE**
The date on which the **boat** was first launched, or the date on which the **boat** was re-launched following any hull shell **modification**, excluding the transom, whichever is the later.

C.6.6 Portable Equipment

Equipment permitted by **class rules** excluding:
the **boat**,
personal equipment, and
consumables.

Typical examples of portable equipment would include, mooring lines, paddles and bailers.

C.7 BOAT MODIFICATIONS, MAINTENANCE AND REPAIR

C.7.1 Terms

(a) INSTALLATION

The **bonding** or **fastening** of a **fitting** directly to the **boat**. This may include the drilling of holes, when and where permitted, through which fasteners are attached.

(b) FITTING

An item, including any associated **fitting**, that is not part of the **boat** structure but is bonded or fastened to the **hull, hull appendages** or **rig**.

(c) FASTENING

To fix in place with bolts, screws or rivets.

(d) BONDING

To fix in place with glues, resins, sealants or other similar chemical agents.

(e) COATING

Application of an additional permanent layer or layers of a substance to a surface. This may require prior preparation of the surface which may involve **sanding**, etching, blasting, but not **fairing**.

(f) SANDING

Removal of the outermost surface through use of an abrasive material with or without a **lubricating** agent, which does not alter the shape but may remove localised irregularities or textures in the surface. It may include polishing through the use of a cutting compound.

(g) CLEANING

The application and subsequent removal of detergents or similar agents, the purpose of which is to remove residue on the surface.

(h) FAIRING

The addition and/or removal of material to alter the shape.

(i) LUBRICATING

The application of non-permanent friction reducing compound.

C.7.2 Modification

Work resulting in a change to the original condition.

C.7.3 Maintenance

Work required to retain the original condition, compensating for normal wear and tear in order to achieve its maximum useful life. This includes preventive **maintenance** and may include **coating, sanding, lubricating** and **cleaning**, but shall exclude **fairing** and **bonding**.

C.7.4 Repair

Corrective action, following unintended damage, required to restore the original condition. This may include **coating, sanding, fairing** and **bonding**.

Section D – Hull Definitions

D.1 HULL TERMS

D.1.1 Hull

The hull shell including any transom, the deck including any superstructure, the internal structure including any cockpit, the **fittings** associated with these parts and any **corrector weights**.

D.1.2 Sheerline

The line formed by the intersection of the top of the deck and the outside of the **hull** shell, each extended as necessary.

D.1.3 Sheer

The projection of the **sheerline** on the centreplane.

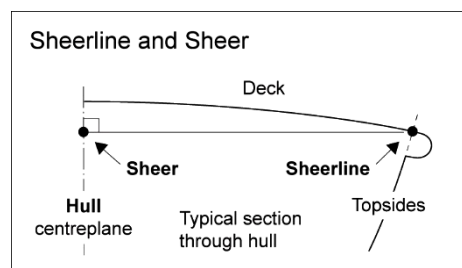

D.2 HULL MEASUREMENT POINTS

D.2.1 Hull Datum Point

A point on the **hull** specified in the **class rules** from which **hull** measurements can be taken.

D.3 HULL DIMENSIONS

D.3.1 Hull Length

The longitudinal distance between the aftermost point and the foremost point on the **hull(s)**, excluding **fittings**.

See H.3.4.

D.3.2 Hull Beam

The maximum transverse distance between the outermost points of the **hull(s)** excluding **fittings**.

D.3.3 Hull Depth

The vertical distance between the **waterplane** and the lowest point of the **hull**.

D.4 WEIGHT

D.4.1 Hull Weight

The weight of the **hull**.

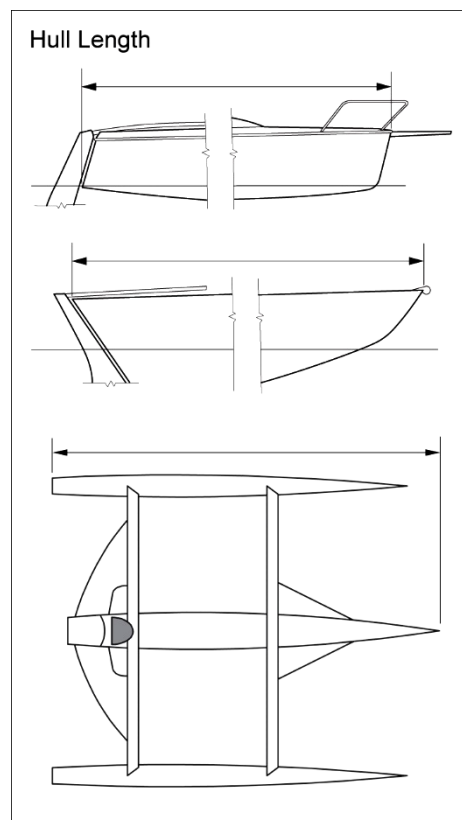

Section E – Hull Appendage Definitions

E.1 HULL APPENDAGE TERMS

E.1.1 Hull Appendage

Any item of equipment – including the items listed in E.1.2– which is:

wholly or partly below the **sheerline** or its extension when fixed or when fully exposed if retractable,
attached to the hull shell or another **hull appendage**, and
used to affect: stability, leeway, steerage, directional stability, motion damping, trim, displaced volume,

Any of the following shall be included in the **hull appendage**:

corrector weights,
integral **ballast**, and
associated **fittings**.

E.1.2 Hull Appendage Types

(a) KEEL

A fixed **hull appendage**, attached approximately on the **hull** centreplane, primarily used to affect stability and leeway.

(b) BILGE KEEL

A fixed **hull appendage**, attached off the **hull** centreplane, primarily used to affect stability and leeway.

(c) CANTING KEEL

A movable **hull appendage** primarily used to affect stability, attached approximately on the **hull** centreplane and rotating around a single longitudinal axis.

(d) FIN

A fixed **hull appendage** primarily used to affect leeway or directional control.

(e) BULB

A **hull appendage** containing **ballast** at the bottom of another **hull appendage** primarily used to affect stability.

(f) SKEG

A **fin** attached immediately in front of a **rudder**.

(g) CENTREBOARD

A retractable **hull appendage**, attached approximately on the **hull** centreplane and rotating about a single transverse axis which may move in relation to the **hull**, primarily used to affect leeway.

(h) DAGGERBOARD

A retractable **hull appendage**, attached approximately on the **hull** centreplane and not rotating, primarily used to affect leeway.

(i) BILGEBOARD

A retractable **hull appendage**, attached off the **hull** centreplane, primarily used to affect leeway.

PART 2 DEFINITIONS

(j) RUDDER

A movable **hull appendage** primarily used to affect steerage.

(k) TRIM TAB

When a **rudder(s)** is used, a movable **hull appendage**, attached at the aft, or fore edge of another **hull appendage**.

(l) WINGLET

A **hull appendage** attached to a **keel, bilge keel** or **bulb**, primarily used to affect leeway and/or lift.

(m) HYDROFOIL

A **hull appendage** primarily used to affect leeway and/or produce vertical lift, which may incorporate any or all of the following:

- Fuselage,
- Foil mast,
- Elevator,
- Front wing,
- Rear wing.

E.2 HULL APPENDAGE MEASUREMENT DEFINITIONS

E.2.1 Hull Appendage Weight

The weight of the **hull appendage**.

E.2.2 Wingspan

The maximum transverse distance between the outermost points of any **winglets** or a **hydrofoil**.

Section F – Rig Definitions

F.1 GENERAL RIG TERMS

F.1.1 Rig

The **spars, spreaders, rigging, fittings** and any **corrector weights**.

F.1.2 Rig Configurations

(a) UNA RIG

A single-masted **rig** with a **mainsail** only.

(b) SLOOP RIG

A single-masted **rig** with a **mainsail** and one **headsail**.

(c) CUTTER RIG

A single-masted **rig** with more than one **headsail**.

(d) KETCH RIG

A two-masted **rig** with the fore mast – the **mainmast** – taller than the aft mast – the **mizzenmast** – set forward of the rudder stock.

(e) YAWL RIG

A two-masted **rig** with the fore mast – the **mainmast** – taller than the aft mast – the **mizzenmast** – set aft of the rudder stock.

(f) SCHOONER RIG

A two-masted **rig** with the fore mast – the **foremast** – shorter than, or the same height as, the aft mast – the **mainmast**.

F.1.3 Spar(s)

The main structural part(s) of the **rig** to which **sails** are **connected**. It includes its **fittings** and any **corrector weights**.

(a) SPAR WEIGHT

The weight of the **spar**.

F.1.4 Spar Types

(a) MAST

A **spar** on which the **head** or **throat** of a **sail**, or a **yard**, is **connected**. Includes its **standing rigging, running rigging**, and **spreader**s, but not **running rigging** and **fittings** that are not essential to the function of the mast as part of the **rig**.

Mast Types:

(i) MAINMAST

(a) The only **mast** in a **una rig, sloop rig** or **cutter rig**.

(b) The fore **mast** in a **ketch rig** or **yawl rig**.

(c) The aft **mast** in a **schooner rig**.

(ii) FOREMAST

The fore **mast** in a **schooner rig**.

(iii) MIZZENMAST

The aft **mast** in a **ketch rig** or **yawl rig**.

(b) BOOM

A **spar** attached at one end to a mast **spar** or a **hull** and on which the **clew** of a **sail** is **connected** and on which the **tack** and/or **foot** of the **sail** may be **connected**. Includes its **rigging**, but not **running rigging**, **running rigging** blocks and/or any kicking strap/strut arrangement.

Boom Types:

(i) FOREMAST SAIL BOOM

A **boom** attached to a **foremast spar** to **connect** a **foremast sail**.

(ii) HEADSAIL BOOM

A **boom** attached to a **hull** to **connect** a **headsail clew**.

(iii) MAIN BOOM

A **boom** attached to a **mainmast spar** to **connect** a **mainsail**.

(iv) MIZZEN BOOM

A **boom** attached to a **mizzenmast spar** to **connect** a **mizzen**.

(v) WISHBONE BOOM

A double **boom** attached to a mast **spar** to **connect** a **sail** and which has one **spar** on each side of the **sail**.

(c) HULL SPARS

A **spar** attached to the **hull**.

(i) BOWSPRIT

A **hull spar** extending forward to **connect rigging** and/or the **tack** of a **headsail**, **headsails** or a **spinnaker**.

(ii) BUMKIN

A **hull spar** extending aft of the **hull** to **connect rigging**.

(iii) DECK SPREADER

A **hull spar** extending transversely to **connect standing rigging**.

(iv) OUTRIGGER

A **hull spar** extending transversely **connected** to a **sheet**.

(d) OTHER SPARS

Other **spar** types include their **rigging**, but not **running rigging**.

Other **Spar** Types:

(i) SPINNAKER POLE

A **spar** attached to the mast **spar** and **connected** to a **spinnaker guy**.

(ii) WHISKER POLE

A **spar** attached to the mast **spar** and **connected** to a **headsail clew**.

(iii) GAFF

A **spar** attached at one end to a mast **spar** to **connect** the peak, throat and/or head of a quadrilateral **sail**.

(iv) SPRIT

A **spar** attached at one end to a mast **spar** or a **hull** to **connect** only the peak of a quadrilateral **sail**.

(v) YARD

A **spar** hoisted on a mast **spar** at a point between its ends to **connect** the **head** of a quadrilateral sail or the **luff** of a lateen **sail**.

(vi) **BAR**

A **spar** to **connect** and control a **kite**.

(vii) **JOCKEY POLE**

A **spar** attached to the **hull** or mast **spar**, extending transversely and **connected** to a **spinnaker guy**.

F.1.5 **Spreader**

Equipment used to brace a **spar**, attached at one end to the **spar** and **connected** at the other end to **standing rigging**, working in compression when in use.

F.1.6 **Rigging**

Any equipment attached and/or **connected** at one or both ends to **spars**, **sails** or other **rigging** and capable of working in tension only. Includes associated **fittings** which are not permanently fixed to a **hull**, **spar** or **spreader**.

F.1.7 **Rigging Types**

(a) **STANDING RIGGING**

Rigging used to support a mast **spar** or **hull spar**. It may be adjustable but is not detached when *racing* except as below:

Standing Rigging types:

(i) **SHROUD**

Rigging used to provide transverse support for a mast **spar** or **hull spar** and which may also provide longitudinal support.

(ii) **STAY**

Rigging mainly used to provide longitudinal support for a mast **spar** or **hull spar** or a **sail** which may be detached while *racing*.

(iii) **FORESTAY**

Rigging used to provide forward support for a mast **spar**.

(b) **RUNNING RIGGING**

Rigging primarily used to adjust a **spar**, a **sail** or a **hull appendage**.

Running Rigging types:

(i) **HALYARD**

Rigging used to hoist a **sail**, **spar**, flag or a combination thereof.

(ii) **BACKSTAY**

Rigging mainly used to provide aft support for a mast **spar** above the **upper limit mark**.

(iii) **RUNNING BACKSTAY**

Rigging used to provide aft support for a mast **spar** at a point, or points, between the **upper limit mark** and the **forestay rigging point**.

(iv) **CHECKSTAY**

Rigging used to provide aft support for a mast **spar** at a point, or points, between the **lower limit mark** and the **forestay rigging point**.

(v) **OUTHHAUL**

Rigging used to trim the **clew** of a **sail** along a boom **spar**.

(vi) **SHEET**

Rigging used to trim the **clew** of a **sail**, or a boom **spar**.

(vii) SPINNAKER GUY

Rigging used to trim the **tack** of a **spinnaker**.

(viii) FLYING LINES

Rigging used to trim a **kite**.

(ix) FRONT LINES

Flying lines used to transfer the power from a **kite** to the **crew**.

(x) BACK LINES

Flying lines used for steering a **kite**.

(c) OTHER RIGGING

(i) TRAPEZE

Rigging attached to a mast **spar** used to support a single **crew** member.

F.1.8 Foretriangle

The area formed by the foreside of the foremost mast **spar**, the foremost **forestay** and the deck including any superstructure.

F.1.9 Limit Marks

(a) LIMIT MARK DIMENSIONS

(i) LIMIT MARK WIDTH

The minimum width measured in the length direction of the **spar**.

F.2 MAST MEASUREMENT DEFINITIONS

F.2.1 Mast Limit Marks

(a) LOWER LIMIT MARK

The **limit mark** for the setting of a boom **spar** or **sail**.

(b) UPPER LIMIT MARK

The limit mark for the setting of a **sail**.

F.2.2 Mast Measurement Points

(a) MAST DATUM POINT

The point on the **mast** specified in the **class rules** used as a datum for measurement.

(b) HEEL POINT

The lowest point on the **spar** and its **fittings**.

(c) TOP POINT

The highest point on the **spar** and its **fittings**.

(d) LOWER POINT

The highest point of the **lower limit mark** at the aft edge of the **spar**.

(e) UPPER POINT

The lowest point of the **upper limit mark** at the aft edge of the **spar**.

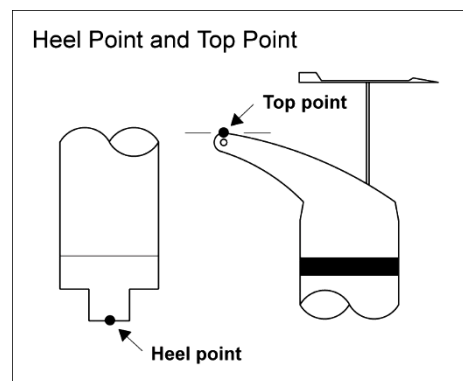

F.2.3 Mast Dimensions

See H.4.

(a) MAST LENGTH

The distance between the **heel point** and the **top point**.

(b) LOWER POINT HEIGHT

The distance between the **mast datum point** and the **lower point**.

(c) UPPER POINT HEIGHT

The distance between the **mast datum point** and the **upper point**.

(d) MAINSAIL LUFF MAST DISTANCE

The distance between the **lower point** and the **upper point**.

(e) RIGGING POINT

When **rigging** is attached:

BY HOOK TERMINAL: The lowest point of the hook where it intersects the **spar**, extended as necessary.

BY TANG WITH THROUGH FIXING: The lowest point of the **spar** through fixing where it intersects the **spar**.

BY EYE WITH BOLT OR OTHER THROUGH FIXING: The lowest point of the **spar** bolt, or through fixing, where it intersects the **spar**.

IN OTHER WAYS: The intersection of the outside of the **spar**, extended as necessary, and the centreline of the **rigging**.

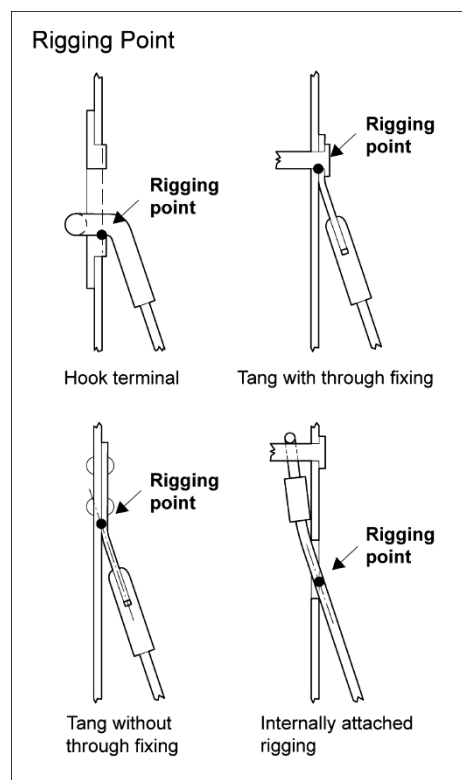

(f) FORESTAY HEIGHT

The distance between the **mast datum point** and the **rigging point** or the **top point** whichever is the lowest.

(g) SHROUD HEIGHT

The distance between the **mast datum point** and the **rigging point**.

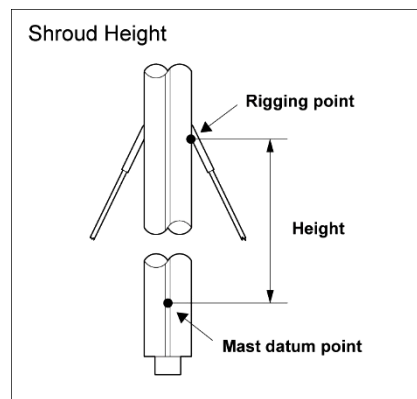
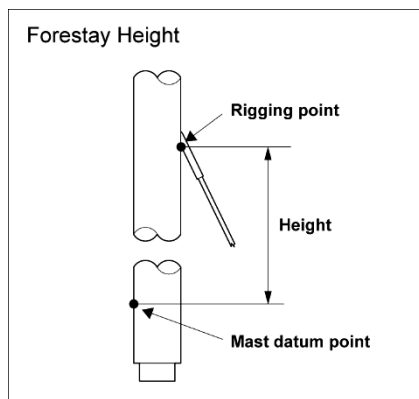

PART 2 DEFINITIONS

(h) **BACKSTAY HEIGHT**

The distance between the **mast datum point** and the **rigging point** or the **top point** whichever is the lowest.

(i) **CHECKSTAY HEIGHT**

The distance between the **mast datum point** and the **rigging point**.

(j) **TRAPEZE HEIGHT**

The distance between the **mast datum point** and the **rigging point**.

(k) **HEADSAIL HOIST HEIGHT**

The distance between the **mast datum point** and the intersection of the **spar** and the lower edge of the **headsail halyard**, when at 90° to the **spar**, each extended as necessary.

(l) **SPINNAKER HOIST HEIGHT**

The distance between the **mast datum point** and the intersection of the **spar** and the lower edge of the **spinnaker halyard**, when at 90° to the **spar**, each extended as necessary.

(m) **MAST SPAR CURVATURE**

The greatest distance between
the **spar**
and a straight line from the **upper point**
to the **lower point**
taken at 90° to the straight line when
the **spar** is resting on one side.

(n) **MAST SPAR DEFLECTION**

The difference in distance, at a
specified distance from the **mast datum point**, between

the **spar**
and a straight line from the **upper point**
to the **lower point**

taken at 90° to the straight line with and
without a specified load at the specified
distance when the **spar** is horizontal at
and supported at these points.

(i) **FORE-AND-AFT**: Measured with
the aft edge up.

(ii) **TRANSVERSE**: Measured with one side up.

See H.4.5.

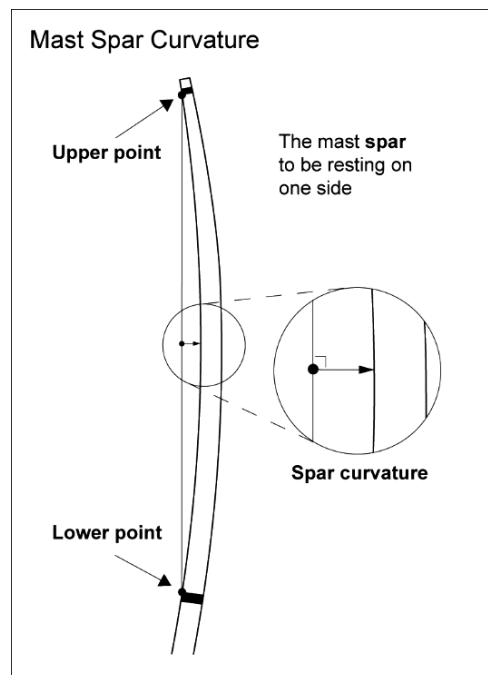
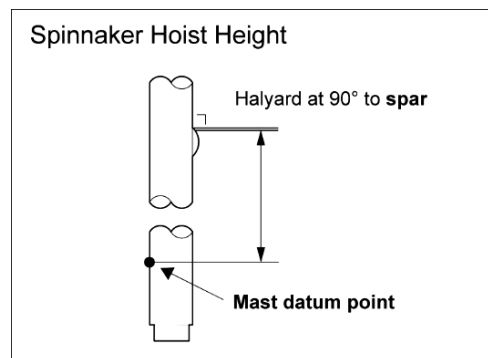

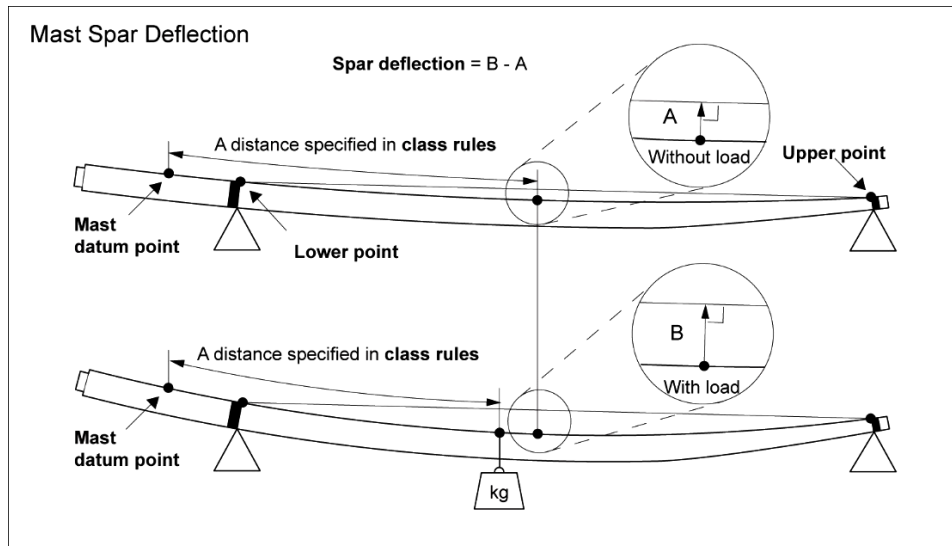

(o) MAST SPAR CROSS SECTION

- (i) FORE-AND-AFT: The fore-and-aft dimension, including any **sail track**, at a specified distance from the **mast datum point**.
- (ii) TRANSVERSE: The transverse dimension, at a specified distance from the **mast datum point**.

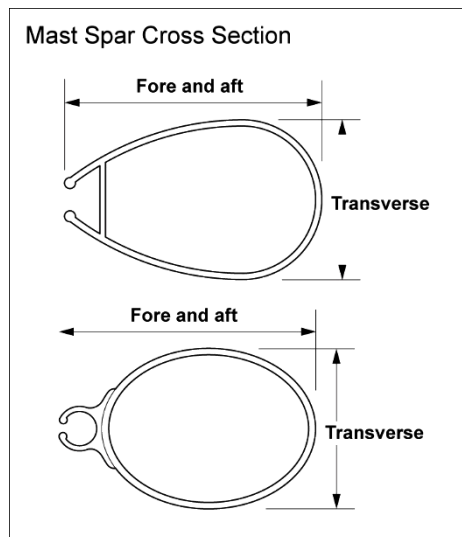

(p) MAST WEIGHT

The weight of the **mast**.

(q) MAST TIP WEIGHT

The weight at the **upper point** when the **mast** is horizontal and supported at the **lower point**.

See H.4.6.

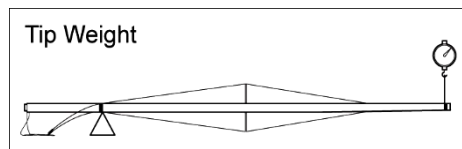

(r) MAST CENTRE OF GRAVITY HEIGHT

The distance from the **mast datum point** to centre of gravity of the **mast**.

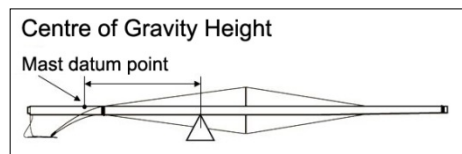

F.2.4 Mast Fittings

(a) SPREADER

- (i) **LENGTH:** The distance between the inner edge of the **shroud** at the lower edge of the **spreader** and the intersection of the lower edge of the **spreader**, extended as necessary, and the **spar**.
- (ii) **HEIGHT:** The distance between **mast datum point** and the intersection of the lower edge of the **spreader**, extended as necessary, and the **spar**.

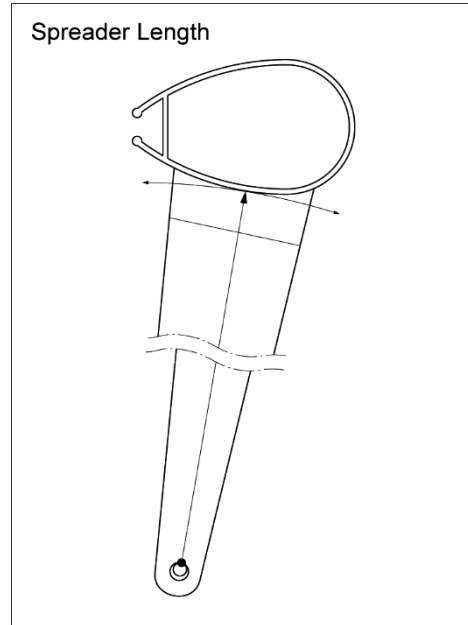
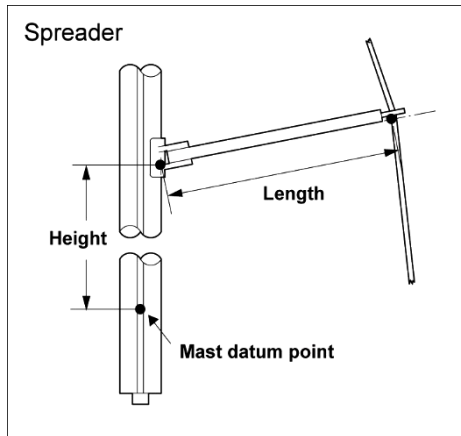

(b) SPINNAKER POLE FITTING

- (i) **HEIGHT:** The distance between the **mast datum point** and the centre of the highest bearing part of the **fitting**.
- (ii) **PROJECTION:** The shortest distance between the outermost point of the **fitting** and the **spar**.

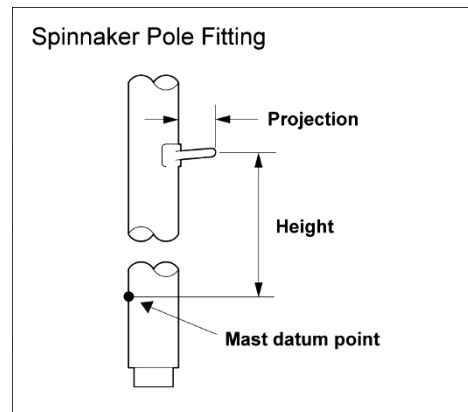

F.3 BOOM MEASUREMENT DEFINITIONS

F.3.1 Boom Measurement Points

(a) OUTER POINT

The point on the boom **outer limit mark**, at the upper edge of the **spar**, nearest the fore end of the **spar**.

F.3.2 Boom Limit Marks

(a) OUTER LIMIT MARK

The **limit mark** for the setting of a **mainsail**, **foresail** or **mizzen**.

F.3.3 Boom Dimensions

See H.4.

(a) OUTER POINT DISTANCE

The distance between the **outer point** and the aft edge of the mast **spar**, with the boom **spar** on the mast **spar** centreplane and at 90° to the mast **spar**.

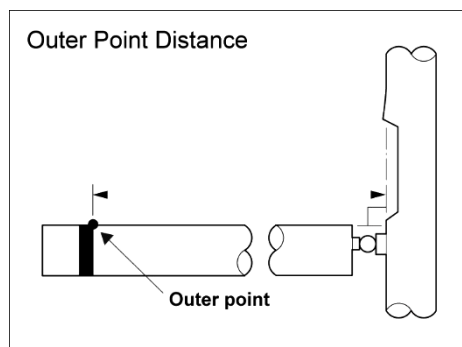

(b) BOOM SPAR CURVATURE

The greatest distance between the **spar** and a straight line from the uppermost fore end of the **spar** to the **outer point** or, where there is no **outer point**, to the uppermost aft end of the **spar**,

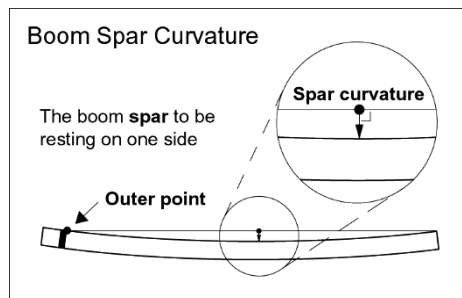

taken at 90° to the straight line when the spar is resting on one side.

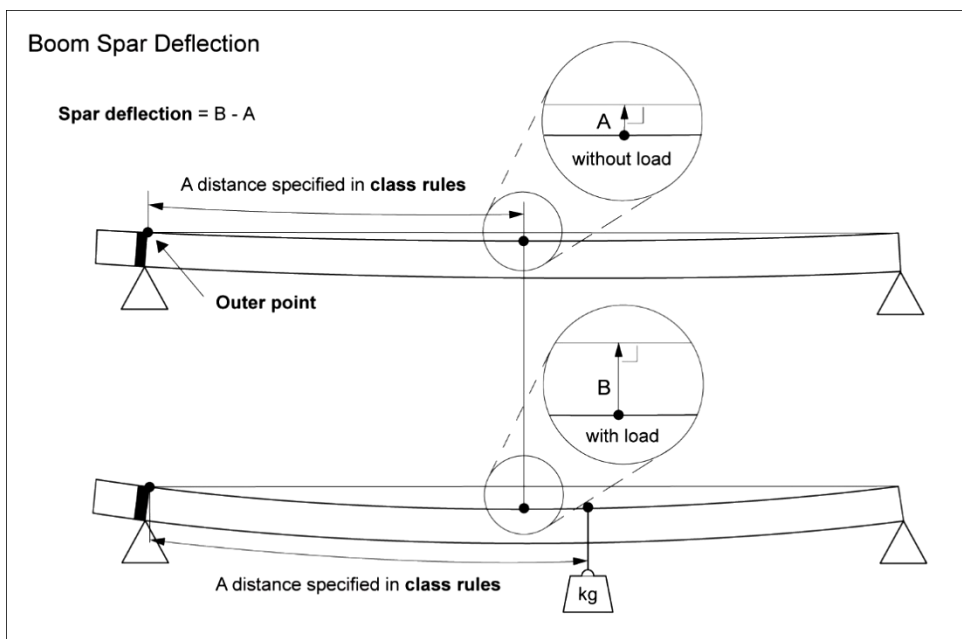

PART 2 DEFINITIONS

(c) BOOM SPAR DEFLECTION

The difference in distance, at a specified distance from the **outer point**, between

the **spar**

and a straight line from the **outer point** to the top of the fore end of the **spar**

taken at 90° to the straight line and with and without a specified load at the specified distance when the **spar** is horizontal and supported at these points.

(i) VERTICAL: Measured with the top edge up.

(ii) TRANSVERSE: Measured with one side up.

See H.4.5.

(d) BOOM SPAR CROSS SECTION

(i) VERTICAL: The vertical dimension, including any **sail** track, at a specified distance from the **outer point**.

(ii) TRANSVERSE: The transverse dimension at a specified distance from the **outer point**.

(e) BOOM WEIGHT

The weight of the **boom**.

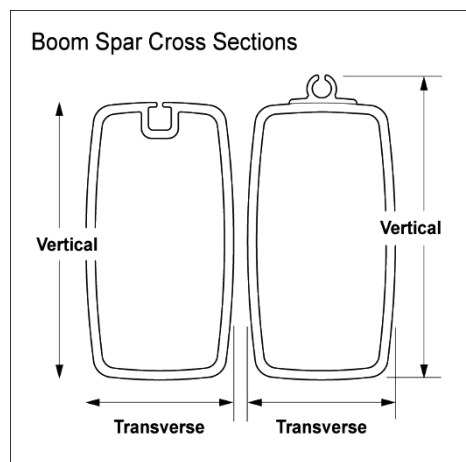

F.4 OTHER SPARS MEASUREMENT DIMENSIONS (REF. F.1.4(D))

See H.4.

(a) SPAR LENGTH

The distance between the ends of the **spar**.

(b) SPAR CROSS SECTION

The sectional dimensions at specified distances from an end of the **spar**.

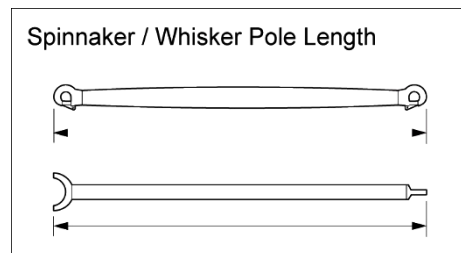

F.5 BOWSPRIT MEASUREMENT DEFINITIONS

F.5.1 Bowsprit Measurement Points

(a) BOWSPRIT INNER POINT

The point of the **bowsprit inner limit mark**, at the upper edge of the **spar**, nearest the outboard end of the **spar**.

(b) BOWSPRIT OUTER POINT

The point of the **bowsprit outer limit mark**, at the upper edge of the **spar**, nearest the inner end of the **spar**, or the outboard end of the **spar** when there is no **outer limit mark**.

F.5.2 Bowsprit Limit Marks

(a) BOWSPRIT INNER LIMIT MARK

The **limit mark** for the setting of the **spar**.

(b) BOWSPRIT OUTER LIMIT MARK

The **limit mark** for the setting of a **headsail**.

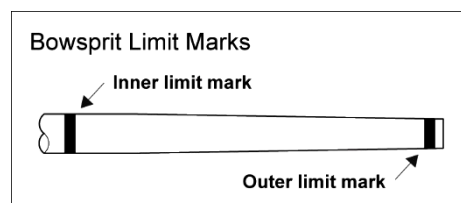

F.5.3 Bowsprit Dimensions

See H.4.

(a) BOWSPRIT POINT DISTANCE

The distance between the **bowsprit inner point** and the **bowsprit outer point**.

(b) BOWSPRIT SPAR CROSS SECTION

The sectional dimensions at specified positions.

(c) BOWSPRIT WEIGHT

The weight of the **bowsprit**.

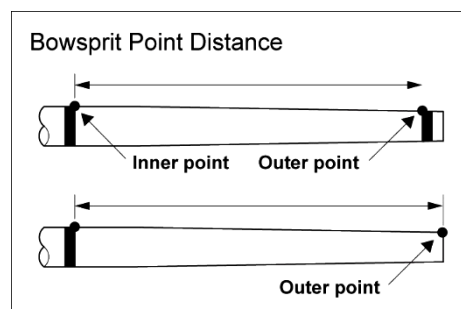

F.6 FORETRIANGLE MEASUREMENT DEFINITIONS

F.6.1 Foretriangle Dimensions

(a) FORETRIANGLE BASE

The longitudinal distance between the intersection of the fore side of the mast **spar**, extended as necessary, and the deck including any superstructure, and the intersection of the centreline of the **forestay**, extended as necessary, and the deck, or bowsprit **spar**.

See H.3.4.

(b) FORETRIANGLE HEIGHT

The distance between the intersection of the **sheer** and the fore side of the mast **spar**, extended as necessary, and the **forestay rigging point**.

See H.4.

(c) FORETRIANGLE AREA

Half the product of the **foretriangle base** and the **foretriangle height**.

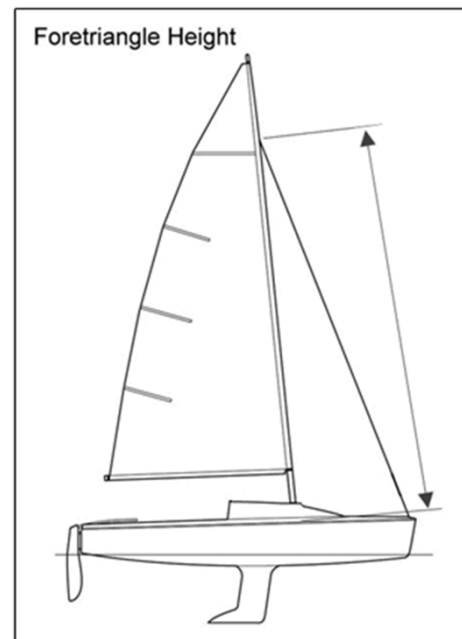
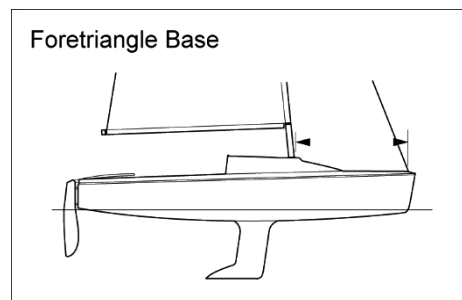

F.7 SAIL SETTING MEASUREMENT DEFINITIONS

F.7.1 Spinnaker Tack Distance

The maximum longitudinal distance from the fore side of the mast **spar** to the end of the longest **spinnaker pole** or the **bowsprit outer point** measured on or near the **boat** centreplane; or the longitudinal distance from the fore side of the mast spar, extended as necessary, and the deck including any superstructure, forward to the **spinnaker** tack point on deck; whichever is the greatest.

Section G – Sail Definitions

Subsection A – Trilateral Sails

Definitions relating to **sails** with only three **sail edges**:

“MAINSAIL” also applies to **foremast sail** and **mizzen**.

“HEADSAIL” also applies to “jib” and “genoa”.

“SPINNAKER” also applies to “gennaker”.

G.1 GENERAL SAIL TERMS

G.1.1 Sail

An item of equipment, used to propel the **boat**. It includes any of the following added parts:

sail reinforcements

batten pockets and associated **fittings**

windows

stiffening

tabling

sail edge ropes and wires

attachments

other parts as permitted by **class rules**.

G.1.2 Set Flying

A **sail** set with no **sail edge** attached to the **rig**.

G.1.3 Sail Types

(a) MAINSAIL

A **sail** with the **luff** attached to the **mainmast spar**. The lowest of the **sails** if more than one **sail** with the **luff** set to that **spar**.

(b) FOREMAST SAIL

A **sail** with the **luff** attached to the **foremast spar**. The lowest of the **sails** if more than one **sail** with the **luff** set to that **spar**.

(c) MIZZEN

A **sail** with the **luff** attached to the **mizzenmast spar**. The lowest of the **sails** if more than one **sail** with the **luff** set to that **spar**.

(d) HEADSAIL

A **sail** set forward of the mast **spar** or of the foremost mast **spar** if more than one mast, where the measurement between the **half luff point** and the **half leech point** is less than 75% of the **foot length**.

(e) KITE

A **sail** connected to the **bar**.

(f) SPINNAKER

A **sail** set forward of the mast **spar** or of the foremost mast **spar** if more than one mast, where the measurement between the **half luff point** and the **half leech point** is equal or greater than 75% of the **foot length**.

G.1.4 Sail Construction

(a) BODY OF THE SAIL

The **sail** excluding the areas where parts are added as per G.1.1.

(b) PLY

A sheet of sail material.

(c) SOFT SAIL

A **sail** where the **body of the sail** is capable of being folded flat in any direction without damaging any **ply** other than by creasing.

(d) WOVEN PLY

A **ply** which, when torn, can be separated into fibres without leaving evidence of a film.

(e) LAMINATED PLY

A **ply** made up of more than one layer.

(f) SINGLE-PLY SAIL

A **sail**, except at **seams**, where all parts of the **body of the sail** consist of only one **ply**.

(g) DOUBLE LUFF SAIL

A **sail** with more than one **luff**, or a **sail** passing around a **spar** and attached back on itself.

(h) SEAM

Overlap where two or more **ply** forming the **body of the sail** are joined.

(i) DART

An overlap formed at a **sail edge** by overlapping the **ply** edges of a cut in the **body of the sail**.

(j) TUCK

Overlap where a **ply** is folded and joined.

(k) BATTEN POCKET

Ply to form a pocket for a batten.

(l) SAIL OPENING

Any opening other than openings created by **attachments** or **batten pockets**.

(m) WINDOW

A predominantly transparent **ply** in the **body of the sail**.

(n) STIFFENING

Corner boards and battens.

(o) ATTACHMENTS

cringles
straps
hanks
slides
adjustment eyes
adjustment points
reefing eyes
reefing points, and
blocks and their **fastenings**.

See H.5.3.

(p) SAIL EDGE SHAPE

The shape of a **sail edge** as a comparison with a straight line between **corner points** or,

in the case of a **leech** other than of a gennaker or **spinnaker**, between the **clew point** and the **aft head point**.

G.2 SAIL EDGES

G.2.1 Foot

The bottom edge.

G.2.2 Leech

The aft edge.

G.2.3 Luff

The fore edge.

G.2.4 Sail Leech Hollow

Concavity in the shape of a **leech** between

adjacent **batten pockets**, or

a **batten pocket** and the adjacent **corner point**, or

in the case of a **mainsail**, **foremast sail**, **mizzen** or a **headsail** other than a **spinnaker** or a gennaker, between the **aft head point** and the adjacent **batten pocket**.

G.3 SAIL CORNERS

G.3.1 Clew

The region where the **foot** and the **leech** meet.

G.3.2 Head

The region at the top.

G.3.3 Tack

The region where the **luff** and the **foot** meet.

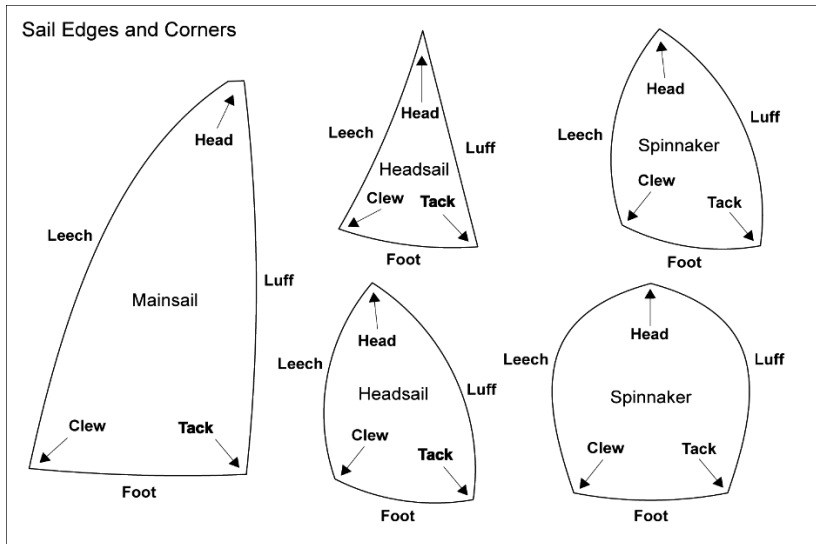

G.4 SAIL CORNER MEASUREMENT POINTS

G.4.1 Clew Point

The intersection of the **foot** and the **leech**, each extended as necessary.

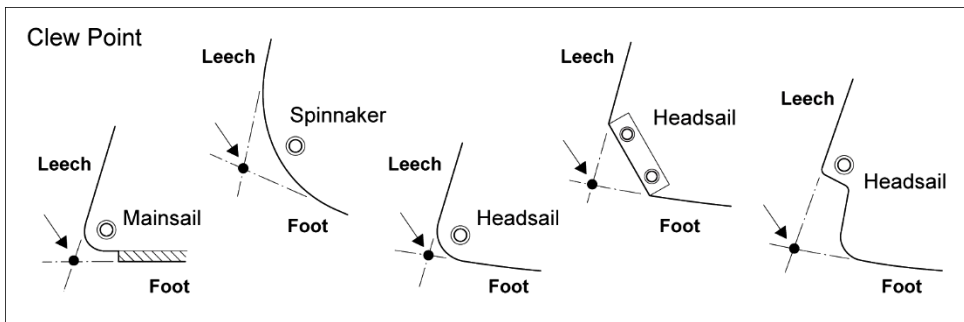

G.4.2 Head Point

- MAINSAIL:** The intersection of the **luff**, extended as necessary, and the line through the highest point of the **sail** at 90° to the **luff**.
- HEADSAIL:** The intersection of the **luff**, extended as necessary, and the line at 90° to the **luff** passing through the highest point of the **sail** excluding **attachments** and any luff tape.
- SPINNAKER:** The intersection of the **luff** and the **leech**, extended as necessary.

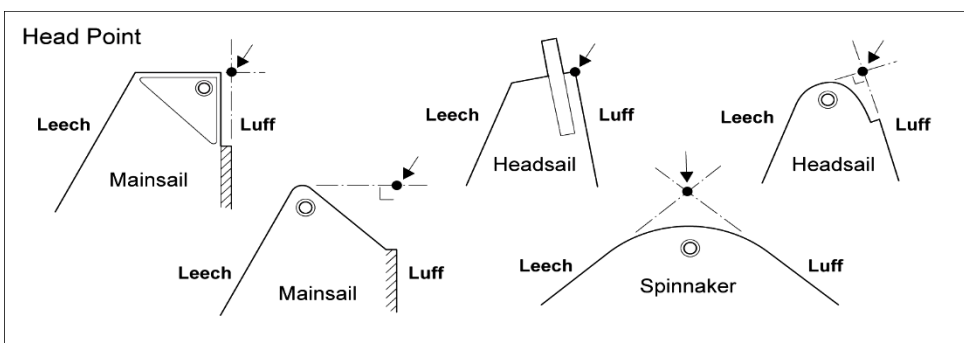
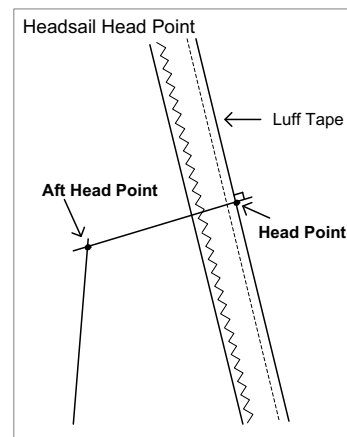

G.4.3 Tack Point

The intersection of the **foot** and the **luff**, each extended as necessary.

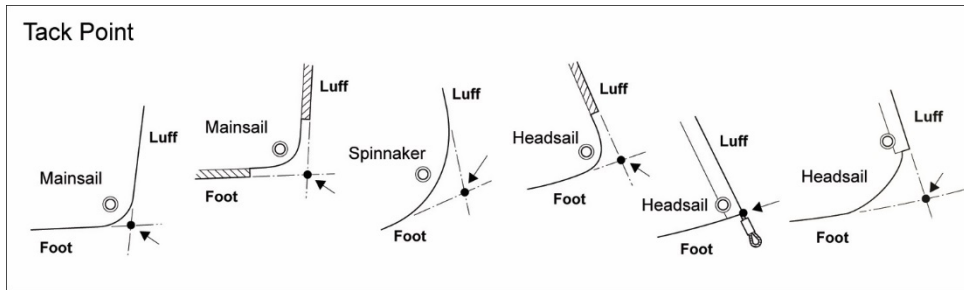

G.5 OTHER SAIL MEASUREMENT POINTS

G.5.1 Quarter Leech Point

The point on the **leech** equidistant from the **half leech point** and the **clew point**.

G.5.2 Half Leech Point

The point on the **leech** equidistant from the **head point** and the **clew point**.

G.5.3 Three-Quarter Leech Point

The point on the **leech** equidistant from the **head point** and the **half leech point**.

G.5.4 Seven-Eighths Leech Point

The point on the **leech** equidistant from the **head point** and the **three-quarter leech point**.

G.5.5 Upper Leech Point

The point on the **leech** a specified distance from the **head point**.

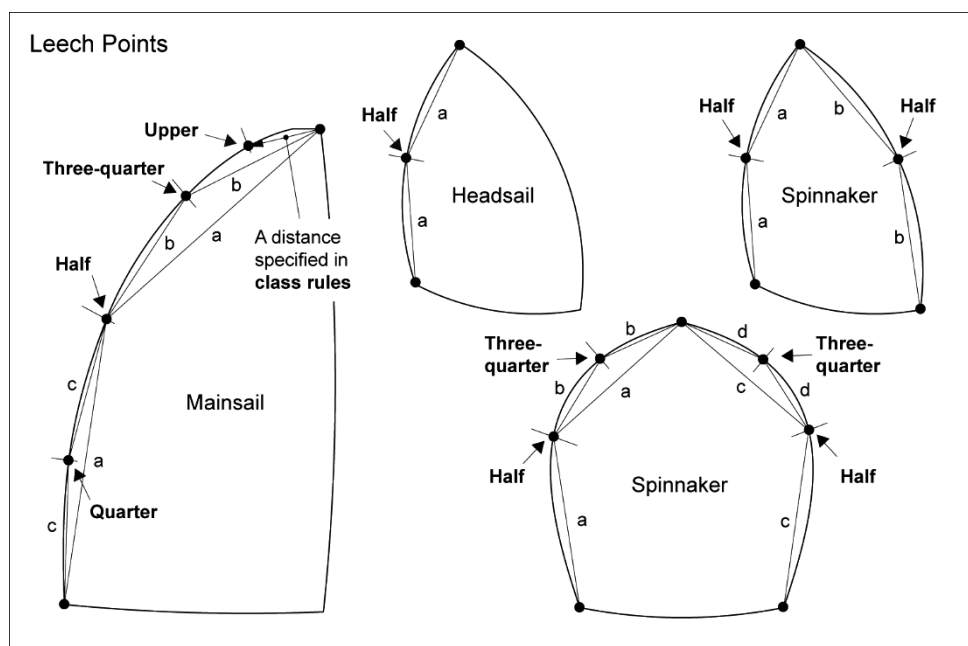

G.5.6 Aft Head Point

MAINSAIL and **HEADSAIL**: The intersection of the **leech** extended as necessary and the line through the **head point** at 90° to the **luff**.

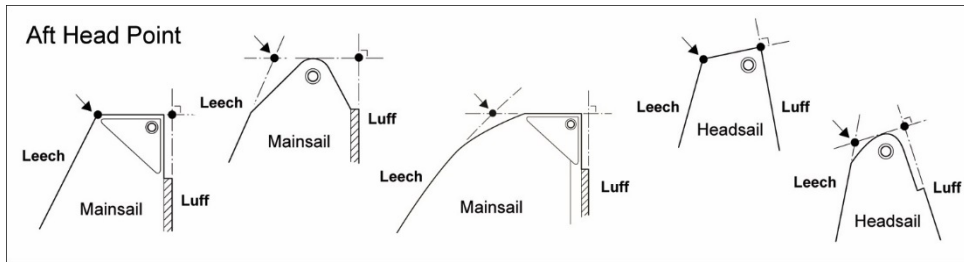

G.5.7 Quarter Luff Point

The point on the **luff** equidistant from the **half luff point** and the **tack point**.

G.5.8 Half Luff Point

The point on the **luff** equidistant from the **head point** and the **tack point**.

G.5.9 Three-Quarter Luff Point

The point on the **luff** equidistant from the **head point** and the **half luff point**.

G.5.10 Seven-Eighths Luff Point

The point on the **luff** equidistant from the **head point** and the **three-quarter luff point**.

G.5.11 Upper Luff Point

The point on the **luff** a specified distance from the **head point**.

G.5.12 Mid Foot Point

The point on the **foot** equidistant from the **tack point** and the **clew point**.

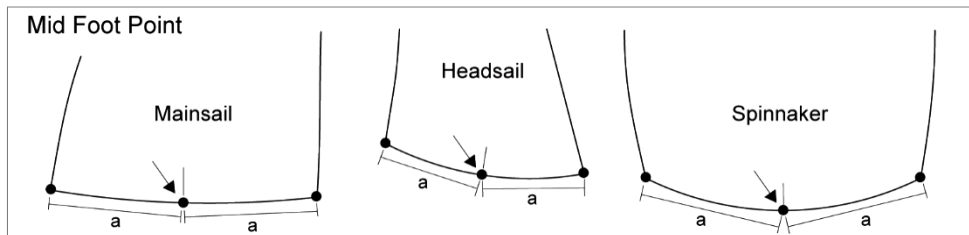

G.6 SAIL REINFORCEMENT

G.6.1 Primary Reinforcement

An unrestricted number of additional layers of **ply** of permitted material:

- at a corner
- at an adjustment point
- at a reefing point adjacent to the **luff**
- at a reefing point adjacent to the **leech**
- at a **sail** recovery point
- where permitted by the **class rules**

G.6.2 Secondary Reinforcement

Not more than two additional layers of **ply** of permitted material each not thicker than the maximum thickness of the **ply** of the **body of the sail**:

- at a corner
- at an adjustment point
- at a reefing point
- at a **sail** recovery point
- to form a **flutter patch**
- to form a **chafing patch**
- to form a **batten pocket patch**
- where permitted by the **class rules**

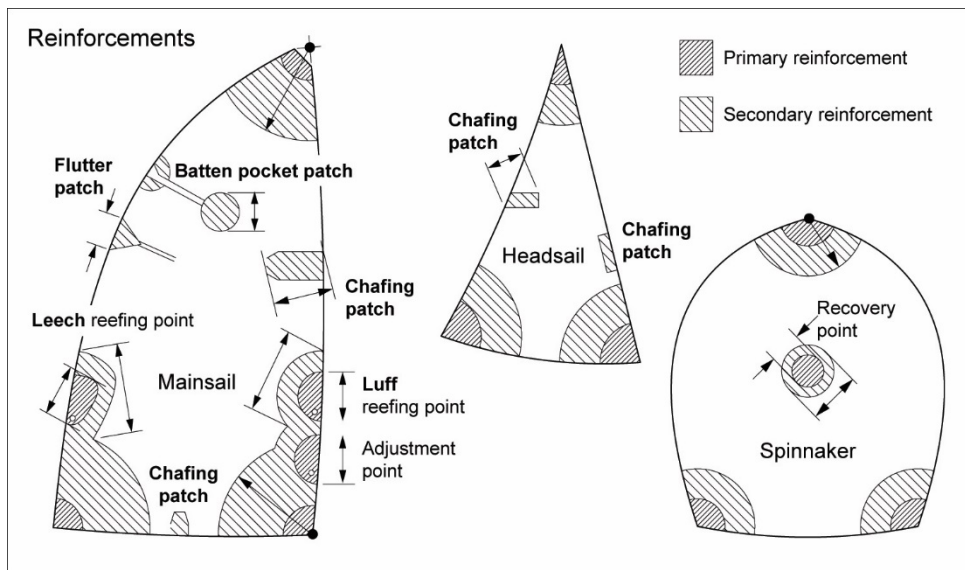

G.6.3 Tabling

Additional **ply** and/or folded **ply** overlap(s) at a **sail edge**.

G.6.4 Batten Pocket Patch

Secondary reinforcement at an end of a **batten pocket**.

G.6.5 Chafing Patch

Secondary reinforcement where a **sail** can touch a **spreader**, stanchion, **shroud** or **spinnaker pole**.

G.6.6 Flutter Patch

Secondary reinforcement on the **leech** or the **foot** at the end of a **seam**.

G.7 PRIMARY SAIL DIMENSIONS

See H.5.

G.7.1 Foot Length

The distance between the **clew point** and the **tack point**.

G.7.2 Leech Length

The distance between the **head point** and the **clew point**.

G.7.3 Luff Length

The distance between the **head point** and the **tack point**.

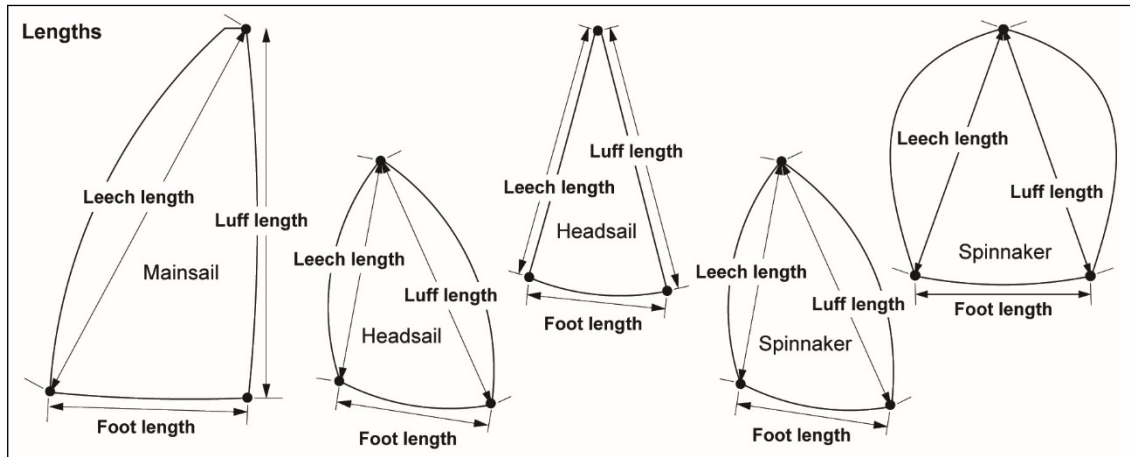

G.7.4 Quarter Width

- (a) MAINSAIL and HEADSAIL: The shortest distance between the **quarter leech point** and the **luff**.
- (b) SPINNAKER: The distance between the **quarter luff point** and the **quarter leech point**.

G.7.5 Half Width

- (a) MAINSAIL and HEADSAIL: The shortest distance between the **half leech point** and the **luff**.
- (b) SPINNAKER: The distance between the **half luff point** and the **half leech point**.

G.7.6 Three-Quarter Width

- (a) MAINSAIL and HEADSAIL: The shortest distance between the **three-quarter leech point** and the **luff**.
- (b) SPINNAKER: The distance between the **three-quarter luff point** and **three-quarter leech point**.

G.7.7 Seven-Eighths Width

- (a) MAINSAIL and HEADSAIL: The shortest distance between the **seven-eighths leech point** and the **luff**.
- (b) SPINNAKER: The distance between the **seven-eighths leech point** and the **seven-eighths luff point**.

G.7.8 Upper Width

- (a) MAINSAIL and HEADSAIL: The shortest distance between the **upper leech point** and the **luff**.
- (b) SPINNAKER: The distance between the **upper luff point** and the **upper leech point**.

G.7.9 Top Width

- (a) MAINSAIL and HEADSAIL: The distance between the **head point** and the **aft head point**.

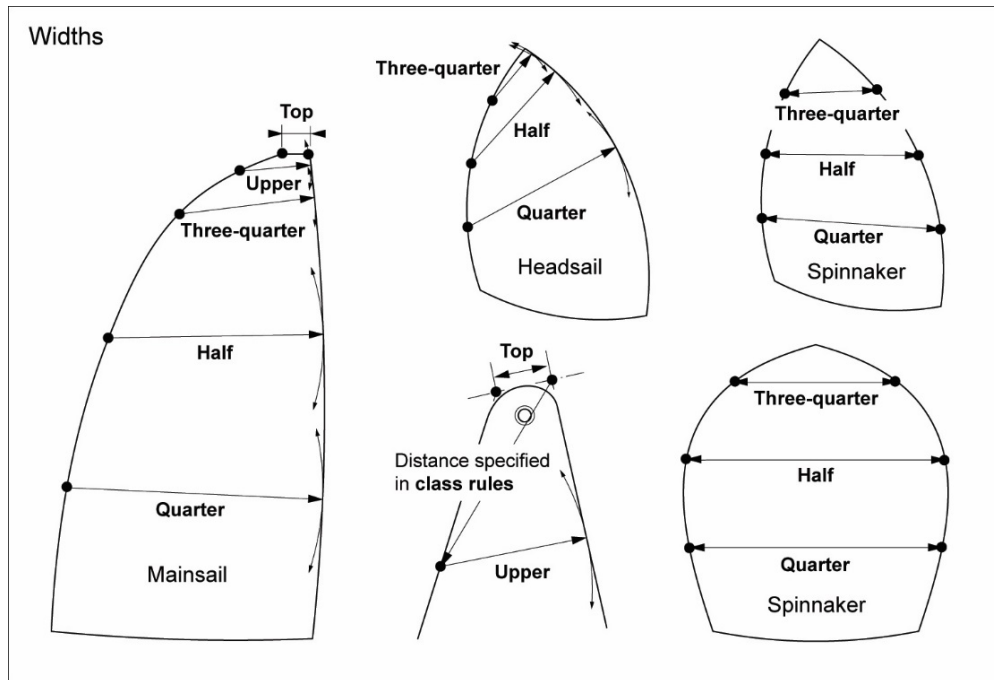

G.7.10 Diagonals

- (a) CLEW DIAGONAL: The distance between the **clew point** and the **half luff point**.
- (b) TACK DIAGONAL: The distance between the **tack point** and the **half leech point**.

G.7.11 Foot Median

The distance between the **head point** and the **mid foot point**.

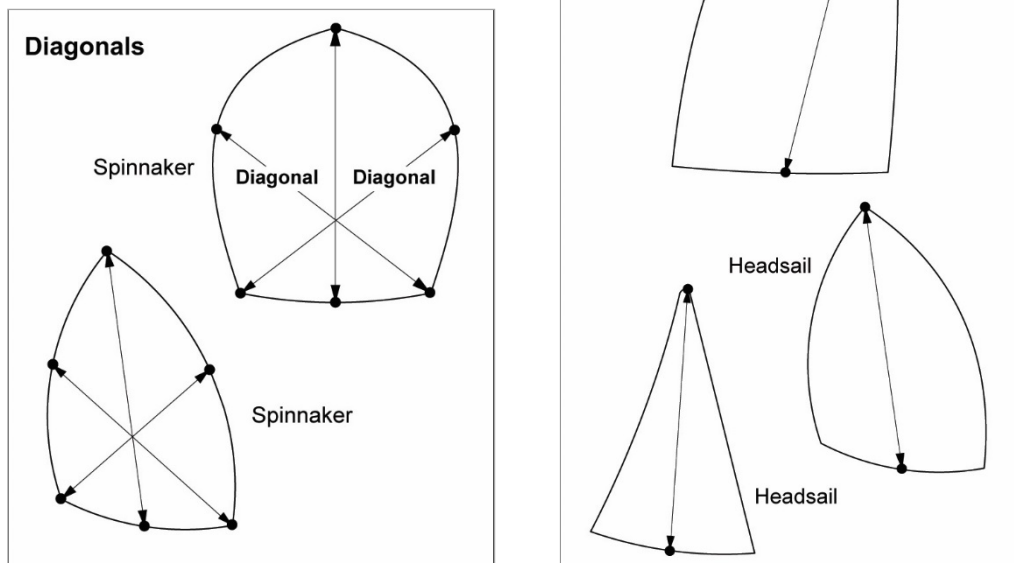

G.7.12 Luff Perpendicular

The shortest distance between the **clew point** and the **luff**.

G.8 OTHER SAIL DIMENSIONS

See H.5.

G.8.1 Batten Pocket Length

- (a) **INSIDE:** The greatest distance between the **sail edge** and the internal extreme end of the **batten pocket**, measured parallel to the pocket centreline. The effect of any elastic or other retaining device and any local widening for batten insertion shall be ignored.
- (b) **OUTSIDE:** The greatest distance between the **sail edge** and the external extreme end of the **batten pocket**, measured parallel to the pocket centreline. The effect of any local widening for batten insertion shall be ignored.

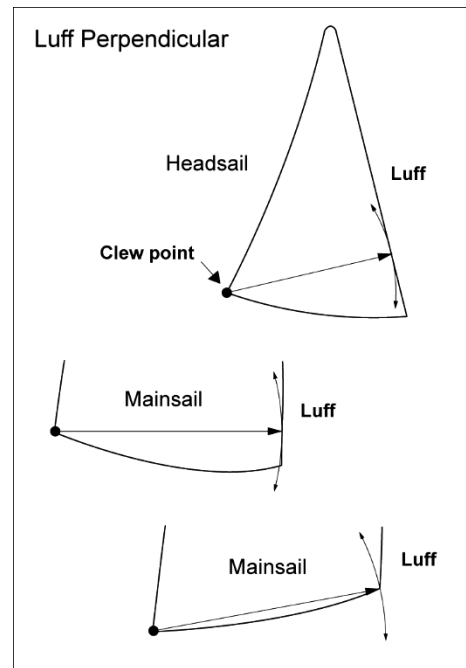

G.8.2 Batten Pocket Width

- (a) **INSIDE:** The greatest distance between inside edges of the **batten pocket** measured at 90° to pocket centreline. Local widening for batten insertion shall be ignored.
- (b) **OUTSIDE:** The greatest distance between the outside edges of the **batten pocket** measured at 90° to the pocket centreline. Local widening for batten insertion shall be ignored.

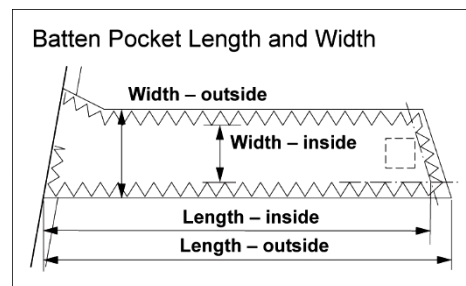

G.8.3 Foot Irregularity

The maximum distance between the edges of the **foot** when first the **tack point** and then the **clew point** are superimposed on any part of the **foot**.

G.8.4 Reinforcement Size

- (a) **AT A CORNER:** The greatest distance measured from the **sail corner measurement point**.
- (b) **TABLING WIDTH:** The width of **tabling** measured at 90° to the **sail edge**.
- (c) **ELSEWHERE:** The greatest dimension of the **sail reinforcement**.

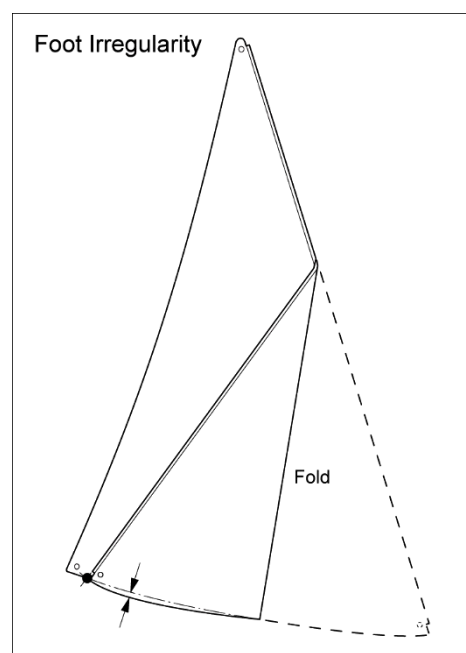

G.8.5 Seam Width

The width of a **seam** measured at 90° to the **seam**.

G.8.6 Dart Width

The width of a **dart** measured at 90° to the **dart** centreline.

G.8.7 Tuck Width

The width of a **tuck** measured at 90° to the **tuck** centreline.

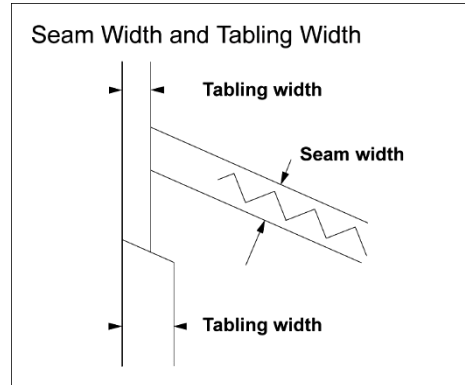

G.8.8 Attachment Size

(a) AT A CORNER OR AN EDGE

(i) LENGTH

AT THE HEAD: The dimension from the **head point** along the **luff** or its extension to a line through the highest point of the **attachment** at 90° to the **luff**.

AT THE TACK: The dimension from the **tack point** along the **luff** or its extension to a line through the lowest point of the **attachment** at 90° to the **luff**.

AT THE CLEW: The greatest dimension from the **clew point**.

AT AN EDGE: The greatest dimension from the **sail edge**.

(ii) WIDTH

The greatest dimension measured perpendicular to the length.

(b) ELSEWHERE

The greatest dimension of the **attachment**.

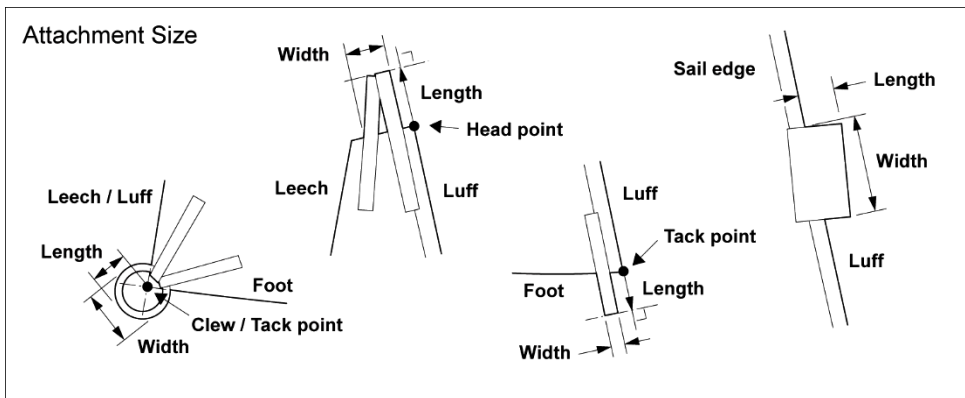
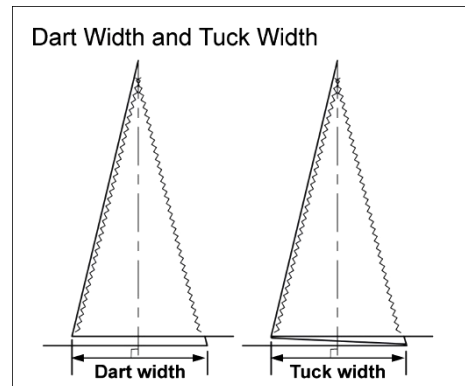

G.8.9 Window Ply Area

The area of the **window ply**.

G.8.10 Window Area

The **window ply** area excluding **seams**.

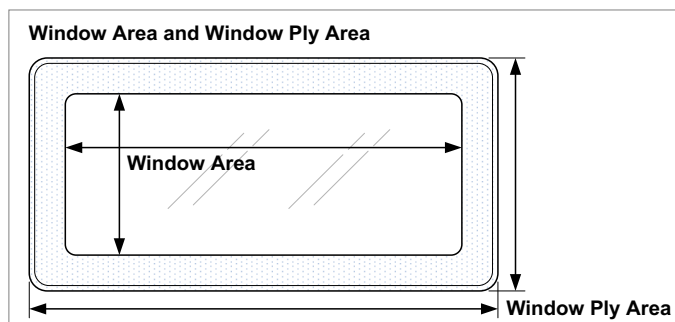

Subsection B – Additions for Other Sails

The following definitions for non-trilateral sails are additional to or vary those given in Subsection A of this Section.

G.2 SAIL EDGES

G.2.5 Head

The top edge.

G.3 SAIL CORNERS

G.3.4 Peak

The region where the **head** and the **leech** meet.

G.3.5 Throat

The region where the **head** and the **luff** meet.

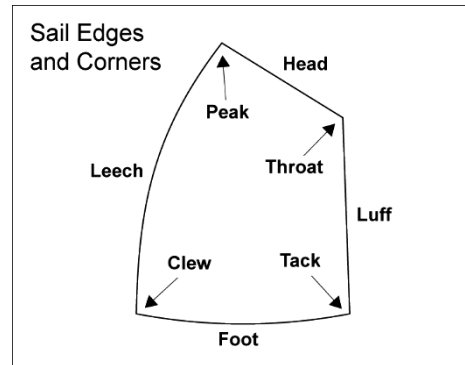

G.4 SAIL CORNER MEASUREMENT POINTS

G.4.4 Peak Point

The intersection of the **head** and **leech**, each extended as necessary.

G.4.5 Throat Point

The intersection of the **head** and **luff**, each extended as necessary.

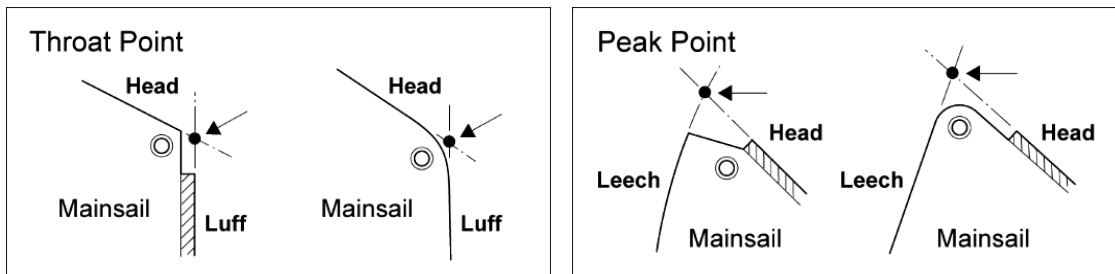

G.5 OTHER SAIL MEASUREMENT POINTS

G.5.2 Half Leech Point

The point on the **leech** equidistant from the **peak point** and the **clew point**.

G.5.3 Three-Quarter Leech Point

The point on the **leech** equidistant from the **peak point** and the **half leech point**.

G.5.4 Seven-Eighths Leech Point

The point on the **leech** equidistant from the **peak point** and the **three-quarter leech point**.

G.5.5 Upper Leech Point

The point on the **leech** a specified distance from the **peak point**.

G.5.8 Half Luff Point

The point on the **luff** equidistant from the **peak point** and the **tack point**.

G.5.9 Three-Quarter Luff Point

The point on the **luff** equidistant from the **peak point** and the **half luff point**.

G.5.10 Seven-Eighths Luff Point

The point on the **luff** equidistant from the **peak point** and the **three-quarter luff point**.

G.7 PRIMARY SAIL DIMENSIONS

See H.5.

G.7.2 Leech Length

The distance between the **peak point** and the **clew point**.

G.7.3 Luff Length

The distance between the **throat point** and the **tack point**.

G.7.10 Diagonals

(a) CLEW DIAGONAL

The distance between the **clew point** and the **throat point**.

(b) TACK DIAGONAL

The distance between the **tack point** and the **peak point**.

G.7.11 Foot Median

The distance between the **peak point** and the **mid foot point**.

G.7.13 Head Length

The distance between the **peak point** and the **throat point**.

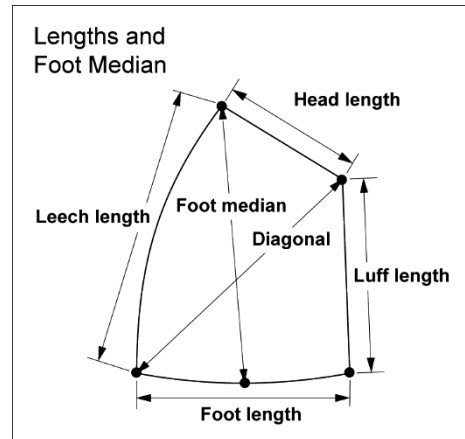

PART 3 – RULES GOVERNING EQUIPMENT CONTROL AND INSPECTION

Section H – Equipment Control and Inspection

H.1 CERTIFICATION CONTROL

- H.1.1** An **official measurer** shall not carry out **certification control** of any part of a **boat** owned, designed or built by himself, or in which he is an interested party, or has a vested interest, except where permitted by the MNA or World Sailing for In-House Certification.
- H.1.2** If an **official measurer** is in any doubt as to the application of, or compliance with, the **class rules** he shall consult the **certification authority** before signing a certification control form or applying a **certification mark**.
- H.1.3** An **official measurer** shall only carry out **certification control** in another country with the prior agreement of the MNA for that country.

H.2 EQUIPMENT INSPECTION

- H.2.1** If an **equipment inspector** is in any doubt as to the application of, or compliance with, the **class rules**, the question should be referred to the **class rules authority**.

H.3 MEASUREMENT AXES

- H.3.1** For a **boat**, unless otherwise specified, words such as “fore”, “aft”, “above”, “below”, “height”, “depth”, “length”, “beam”, “freeboard”, “inboard” and “outboard” shall be taken to refer to the **boat** in **measurement trim**. All measurements denoted by these, or similar words, shall be taken parallel to one of the three **major axes**.
- H.3.2** For a component, unless otherwise specified, width, thickness, length etc. shall be measured as appropriate for that component, if relevant without reference to the **major axes**.
- H.3.3** Unless otherwise specified, measurements shall be the shortest distance between the measurement points.
- H.3.4** Unless otherwise specified, longitudinal measurements shall be taken parallel to the longitudinal **major axis**.

H.4 RIG MEASUREMENT

H.4.1 Measurements in the length direction shall be taken along the **spar** at the side relevant for the measurement and between sectional planes through the measurement points at 90° to the **spar** at each point.

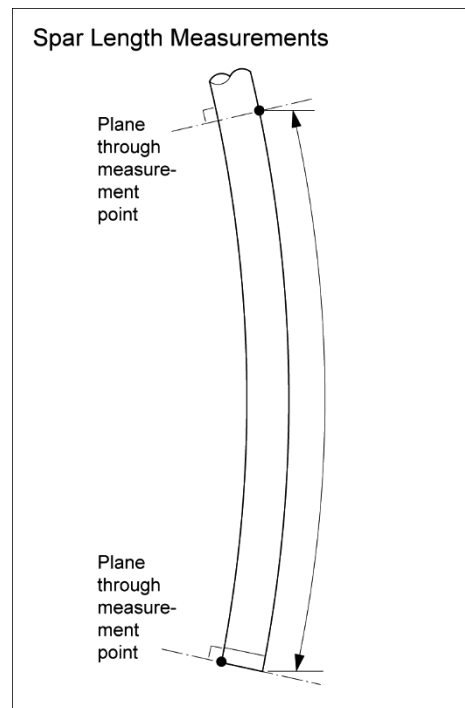
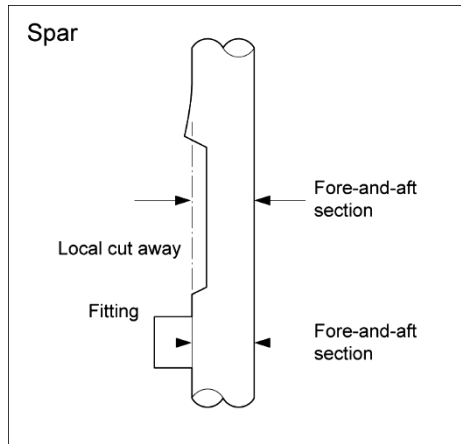

H.4.2 Fittings, local curvature and local cut away, shall be ignored when measuring a **spar** or dimensions taken to a **spar**.

H.4.3 No external pressure shall be applied to a **spar** when measuring unless specifically prescribed.

H.4.4 Adjustable fittings shall be set in the position that gives the greatest value when the measurement is taken.

H.4.5 Mast spar deflection and boom spar deflection shall be checked with free ends of rigging not supported by the spar.

H.4.6 Mast tip weight shall be checked with any halyards fully hoisted and rigging tied to the spar at the lower limit mark with lower ends hanging free or resting on the ground.

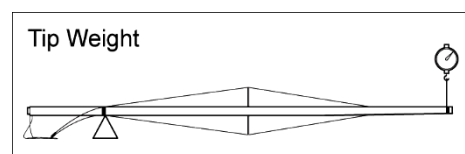

H.4.7 Mast centre of gravity height shall be checked with any halyards fully hoisted and rigging pulled taut and tied to the spar as close to the lower point as possible.

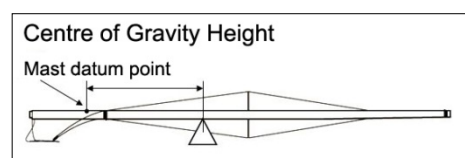

H.5 SAIL MEASUREMENT

H.5.1 Condition of the Sail

For measurement the **sail** shall:

- (a) be dry,
- (b) not be attached to **spars** or **rigging**,
- (c) unless the **class rules** prescribe otherwise, have all battens removed,
- (d) have pockets of any type flattened out,
- (e) have just sufficient tension applied to remove wrinkles across the line of the measurement being taken,
- (f) have only one measurement taken at a time and
- (g) be weighed with all **attachments**.

H.5.2 Hollows in Sail Leeches

Where there is a **sail leech hollow** and a measurement point falls in the hollow:

between adjacent **batten pockets**

between the **aft head point** and adjacent **batten pocket**

between the **clew point** and adjacent **batten pocket**

at an **attachment**.

the **sail** shall be flattened out in the area of the **sail edge**, the **sail edge hollow** shall be bridged by a straight line and the shortest distance from the measurement point to the straight line shall be measured. This distance shall be added to the measurement being taken.

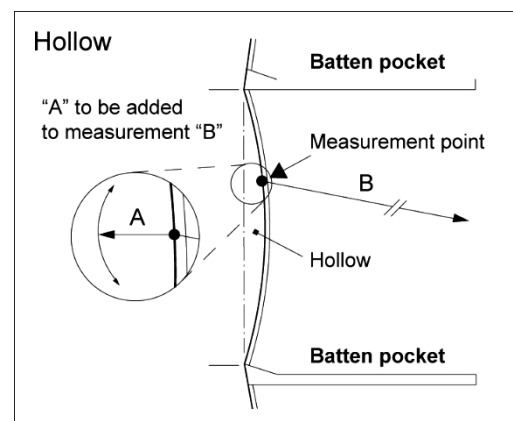

H.5.3 Excluding Attachments

Attachments at a **sail edge**, other than a bolt rope and **tabling**, shall be excluded when measuring.

H.5.4 Extended as necessary

If there is local curvature and/or irregularity in the **sail edge** leading into a corner point, the extension of the **sail edge** shall be found as follows using a batten as specified in H.5.4(e) :-

- (a) Hold the batten at its very ends with one end approximately where the **corner point** will be and the other end touching the **sail edge** being extended.
- (b) Apply compression only to the batten to produce a uniform curve when required.
- (c) If the batten does not replicate the sail edge shape exactly, move the end of the batten at the **corner** away from **sail** until the longest possible length of the batten touches the **sail edge**.
- (d) Where this technique does not provide a repeatable **corner point**, ERS H.1.2 shall apply.
- (e) Battens shall be of a specification approved by World Sailing unless otherwise specified in class rules.

(f) Class Rules may vary ERS H.5.4

H.6 CHECKING MATERIALS

Unless specifically prescribed by the **class rules**, materials are not subject to **certification control**.

H.7 BOAT MEASUREMENT

H.7.1 Conditions for Weight and Flotation Measurement

The **boat** shall:

be dry.

be in compliance with the **class rules**.

Unless otherwise specified in the *rules*, any of the following shall be included:

rig including **spinnaker pole(s)**, **whisker poles** and/or **jockey pole**
main sheet and **mizzen sheet**,

vang,

inboard engine or outboard engine in stowed position,

fitted berth cushions on board in their normal positions,

all permanent fixtures and **fittings** and items of accommodation.

Unless otherwise specified in the *rules*, any of the following shall be excluded:

sails

fuel, water, **variable ballast** or the content of any other tanks,

gas bottles

portable safety equipment

and all other unfitted or loose equipment.

APPENDIX 1

The following rules in The Racing Rules of Sailing govern equipment, the use of equipment and changes to and compliance with **class rules**:

- 1 Safety
- 6.1 World Sailing Regulations
- 40 Personal Flotation Devices
- 42 Propulsion
- 45 Hauling Out; Making Fast; Anchoring
- 47 Trash Disposal
- 48 Limitations on Equipment and Crew
- 49 Crew Position; Lifelines
- 50 Competitor Clothing and Equipment
- 51 Movable Ballast
- 52 Manual Power
- 53 Skin Friction
- 54 Forestays and Headsail Tacks
- 55 Setting and Sheeting Sails
- 56 Fog Signals and Lights; Traffic Separation Schemes
- 64.4 Decisions on Protests Concerning Class Rules
- 77 Identification on Sails
- 78 Compliance with Class Rules; Certificates
- 87 Changes to Class Rules

Appendix G – Identifications on Sails

Appendix H – Weighing Clothing and Equipment

Note that racing rule 86.1 permits some of these racing rules to be changed by prescriptions of a national authority, notice of race or sailing instructions or class rules.

The World Sailing Advertising Code (World Sailing Regulation 20) and Appendices G and H of the racing rules are made applicable by racing rules 6.1, 77 and 50 respectively. That code and those appendices contain rules governing equipment. Certain rules in the International Regulations for Preventing Collisions at Sea (IRPCAS) or applicable government rules are made applicable by racing rule 56, and certain specifications in the World Sailing Offshore Special Regulations are made applicable by racing rule 49.

APPENDIX 2

Abbreviations for primary sail dimensions:

	ERS Rule Reference	Dimension	Abbreviation
Mainsail	G.7.4 (a)	Mainsail Quarter Width	MQW
	G.7.5 (a)	Mainsail Half Width	MHW
	G.7.6 (a)	Mainsail Three Quarter Width	MTW
	G.7.8 (a)	Mainsail Upper Width	MUW
	G.7.9 (a)	Mainsail Top Width	MHB
Headsail	G.7.3	Headsail Luff Length	HLU
	G.7.4 (a)	Headsail Quarter Width	HQW
	G.7.5 (a)	Headsail Half Width	HHW
	G.7.6 (a)	Headsail Three Quarter Width	HTW
	G.7.8 (a)	Headsail Upper Width	HUW
	G.7.9 (a)	Headsail Top Width	HHB
	G.7.11	Headsail Luff Perpendicular	HLP
Spinnaker	G.7.3	Spinnaker Luff Length	SLU
	G.7.2	Spinnaker Leech Length	SLE
	G.7.1	Spinnaker Foot Length	SFL
	G.7.5 (b)	Spinnaker Half Width	SHW

INDEX OF DEFINITIONS

Defined Term	Rule	Defined Term	Rule
A		C	
Aft Head Point	G.5.6	Canting Keel	E.1.2(c)
Age Date	C.6.5(b)	Centreboard	E.1.2(g)
Attachment Size	G.8.8	Certificate	C.3.3
Attachments	G.1.4(o)	Certification Authority	C.3.1
B		Certification Mark	C.3.4
Back Lines	F.1.7(b)(x)	Certification Control	C.4.2
Backstay	F.1.6(b)(ii)	Certify/Certification	C.3.2
Backstay Height	F.2.3(h)	Chafing Patch	G.6.5
Ballast	C.6.3(f)	Checkstay	F.1.7(b)(iv)
Bar	F.1.4(d)(vi)	Checkstay Height	F.2.3(i)
Batten Pocket	G.1.4(k)	Class Authority	C.1.1
Batten Pocket Length	G.8.1	Class Rules	C.2.1
Batten Pocket Patch	G.6.4	Class Rules Authority	C.2.4
Batten Pocket Width	G.8.2	Cleaning	C.7.1(g)
Bilge Keel	E.1.2(b)	Clew	G.3.1
Bilgeboard	E.1.2(i)	Clew Diagonal (trilateral sails)	G.7.10(a)
Boat	C.6.1	Clew Diagonal (other sails)	G.7.10(a) *1
Boat Beam	C.6.4(b)	Clew Point	G.4.1
Boat Length	C.6.4(a)	Closed Class Rules	C.2.2
Boat Weight	C.6.4(h)	Coating	C.7.1(e)
Body of the Sail	G.1.4(a)	Connect	C.6.3(g)
Bonding	C.7.1(d)	Corrector Weight	C.6.3(e)(v)
Boom	F.1.4(b)	Crew	C.5.1
Boom Spar Cross Section	F.3.3(d)	Cutter Rig	F.1.2(c)
Boom Spar Curvature	F.3.3(b)	D	
Boom Spar Deflection	F.3.3(c)	Daggerboard	E.1.2(h)
Boom Weight	F.3.3(e)	Dart	G.1.4(i)
Bowsprit	F.1.4(c)(i)	Dart Width	G.8.6
Bowsprit Inner Limit Mark	F.5.2(a)	Double Luff Sail	G.1.4(g)
Bowsprit Inner Point	F.5.1(a)	Draft	C.6.4(e)
Bowsprit Outer Limit Mark	F.5.2(b)	E	
Bowsprit Outer Point	F.5.1(b)	Event Limitation Mark	C.4.8
Bowsprit Point Distance	F.5.3(a)	External Ballast	C.6.3(e)(ii)
Bowsprit Spar Cross Section	F.5.3(b)	Equipment Inspection	C.4.3
Bowsprit Weight	F.5.3(c)	Equipment Inspector	C.4.6
Bulb	E.1.2(e)	F	
Bumkin	F.1.4(c)(ii)	Fairing	C.7.1(h)
		Fastening	C.7.1(c)

INDEX OF DEFINITIONS

Defined Term	Rule	Defined Term	Rule
Fin	E.1.2(d)	Hull Appendage	E.1.1
Fitting	C.7.1(b)	Hull Appendage Depth	C.6.4(j)
Flotation Trim	C.6.3(c)	Hull Appendage Weight	E.2.1
Flutter Patch	G.6.6	Hull Beam	D.3.2
Flying Lines	F.1.7(b)(viii)	Hull Datum Point	D.2.1
Foil	E.1.2(m)	Hull Depth	D.3.3
Foot	G.2.1	Hull Length	D.3.1
Foot Irregularity	G.8.3	Hull Spars	F.1.4(c)
Foot Length	G.7.1	Hull Weight	D.4.1
Foot Median (trilateral sails)	G.7.11	I	
Foot Median (other sails)	G.7.11 *1	In-house Official Measurer	C.4.5
Foremast	F.1.4(a)(ii)	Installation	C.7.1(a)
Foremast Sail	G.1.3(b)	Internal Ballast	C.6.3(e)(i)
Foremast Sail Boom	F.1.4(b)(i)	J	
Forestay	F.1.7(a)(iii)	Jockey Pole	F.1.4(d)(vii)
Forestay Height	F.2.3(f)	K	
Foretriangle	F.1.8	Keel	E.1.2(a)
Foretriangle Area	F.6.1(c)	Ketch Rig	F.1.2(d)
Foretriangle Base	F.6.1(a)	Kite	G.1.3(e)
Foretriangle Height	F.6.1(b)	Kite-Board	C.6.2(d)
Front Lines	F.1.7(b)(ix)	L	
Fundamental Measurement	C.4.1	Laminated Ply	G.1.4(e)
G		Leech	G.2.2
Gaff	F.1.4(d)(iii)	Leech Length (trilateral sails)	G.7.2
H		Leech Length (other sails)	G.7.2 *1
Half Leech Point (trilateral sails)	G.5.2	Limit Mark	C.4.7
Half Leech Point (other sails)	G.5.2 *1	Limit Mark Width	F.1.9(a)(i)
Half Luff Point	G.5.7	List Angle	C.6.4(i)
Half Width	G.7.5	Lower Limit Mark	F.2.1(a)
Halyard	F.1.7(b)(i)	Lower Point	F.2.2(d)
Head (trilateral sails)	G.3.2	Lower Point Height	F.2.3(b)
Head (other sails)	G.2.5 *1	Lubricating	C.7.1(i)
Head Length	G.7.12 *1	Luff	G.2.3
Head Point	G.4.2	Luff Length (trilateral sails)	G.7.3
Headsail	G.1.3(d)	Luff Length (other sails)	G.7.3 *1
Headsail Boom	F.1.4(b)(ii)	Luff Perpendicular	G.7.12
Headsail Hoist Height	F.2.3(k)	M	
Heel Point	F.2.2(b)	Mainsail	G.1.3(a)
Hull	D.1.1	Mainsail Luff Mast dist.	F.2.3(d)

INDEX OF DEFINITIONS

Defined Term	Rule	Defined Term	Rule
Main Boom	F.1.4(b)(iii)	Portable Equipment	C.6.6
Mainmast	F.1.4(a)(i)	Primary Reinforcement	G.6.1
Maintenance	C.7.3	Q	
Major Axes	C.6.3(a)	Quarter Leech Point	G.5.1
Mast	F.1.4(a)	Quarter Luff Point	G.5.6
Mast Centre of Gravity Height	F.2.3(r)	Quarter Width	G.7.4
Mast Datum Point	F.2.2(a)	R	
Mast Length	F.2.3(a)	Reinforcement Size	G.8.4
Mast Spar Cross Section	F.2.3(o)	Repair	C.7.4
Mast Spar Curvature	F.2.3(m)	Rig	F.1.1
Mast Spar Deflection	F.2.3(n)	Rigging	F.1.6
Mast Tip Weight	F.2.3(q)	Rigging Point	F.2.3(e)
Mast Weight	F.2.3(p)	Rudder	E.1.2(j)
Maximum Draft	C.6.4(g)	Running Backstay	F.1.7(b)(iii)
Measurement Trim	C.6.3(b)	Running Rigging	F.1.7(b)
Mid Foot Point	G.5.12	S	
Minimum Draft	C.6.4(f)	Sail	G.1.1
Mizzen	G.1.3(c)	Sail Corners (trilateral sails)	G.3
Mizzen Boom	F.1.4(b)(iv)	Sail Corners (other sails)	G.3* ¹
Mizzen Mast	F.1.4(a)(iii)	Sail Edge Shape	G.1.4(p)
Modification	C.7.2	Sail Edges (trilateral sails)	G.2
Monohull	C.6.2(a)	Sail Edges (other sails)	G.2* ¹
Movable Ballast	C.6.3(f)(iii)	Sail Leech Hollow	G.2.4
Multihull	C.6.2(b)	Sail Opening	G.1.4(l)
O		Sanding	C.7.1(f)
Official Measurer	C.4.4	Schooner Rig	F.1.2(f)
Open Class Rules	C.2.3	Seam	G.1.4(h)
Outhaul	F.1.7(b)(v)	Seam Width	G.8.5
Outer Limit Mark (boom)	F.3.2(a)	Secondary Reinforcement	G.6.2
Outer Limit Mark (bowsprit)	F.5.2(b)	Series Date	C.6.5(a)
Outer Point	F.3.1(a)	Set Flying	G.1.2
Outer Point Distance	F.3.3(a)	Seven-Eighths Leech Point (trilateral sails)	G.5.4
Outrigger	F.1.4(c)(iv)	Seven-Eighths Leech Point (other sails)	G.5.4* ¹
P		Seven-Eighths Luff Point (trilateral sails)	G.5.10
Peak	G.3.4 * ¹	Seven-Eighths Luff Point (other sails)	G.5.10* ¹
Peak Point	G.4.4 * ¹	Seven-Eighths Width	G.7.7
Personal Equipment	C.5.3		
Personal Flotation Device	C.5.4		
Ply	G.1.4(b)		

INDEX OF DEFINITIONS

Defined Term	Rule	Defined Term	Rule
Sheer	D.1.3	Throat	G.3.5 * ¹
Sheerline	D.1.2	Throat Point	G.4.5 * ¹
Sheet	F.1.7(b)(vi)	Top Point	F.2.2(c)
Shroud	F.1.7(a)(i)	Top Width	G.7.9
Shroud Height	F.2.3(g)	Trapeze	F.1.7(c)(i)
Single-Ply Sail	G.1.4(f)	Trapeze Height	F.2.3(j)
Skeg	E.1.2(f)	Trim Tab	E.1.2(k)
Sloop Rig	F.1.2(b)	Tuck	G.1.4(j)
Soft Sail	G.1.4(c)	Tuck Width	G.8.7
Spar(s)	F.1.3	U	
Spar Cross Section	F.4(b)	Una Rig	F.1.2(a)
Spar Length	F.4(a)	Upper Leech Point (trilateral sails)	G.5.5
Spar Weight	F.1.3(a)	Upper Leech Point (other sails)	G.5.5 * ¹
Spinnaker	G.1.3(f)	Upper Limit Mark	F.2.1(b)
Spinnaker Guy	F.1.7(b)(vii)	Upper Luff Point	G.5.11
Spinnaker Hoist Height	F.2.3(l)	Upper Point	F.2.2(e)
Spinnaker Pole	F.1.4(d)(i)	Upper Point Height	F.2.3(c)
Spinnaker Pole Fitting Height	F.2.4(b)(i)	Upper Width	G.7.8
Spinnaker Pole Fitting Projection	F.2.4(b)(ii)	V	
Spinnaker Pole Spar Cross Section	F.4(b)	Variable Ballast	C.6.3(f)(iv)
Spinnaker Pole Weight	F.4(c)	W	
Spreader	F.1.5	Waterline	C.6.3(d)
Spreader Height	F.2.4(a)(ii)	Waterline Length	C.6.4(c)
Spreader Length	F.2.4(a)(i)	Waterplane	C.6.3(e)
Sprit	F.1.4(d)(vi)	Wishbone Boom	F.1.4(b)(v)
Standing Rigging	F.1.7(a)	Whisker Pole	F.1.4(d)(ii)
Stay	F.1.7(a)(ii)	Whisker Pole Length	F.4(a)
Stiffening	G.1.4(n)	Whisker Pole Spar Cross Section	F.4(b)
T		Whisker Pole Weight	F.4(c)
Tabling	G.6.3	Window	G.1.4(m)
Tabling Width	G.8.4(b)	Window Area	G.8.10
Tack	G.3.3	Window Ply Area	G.8.9
Tack Diagonal	G.7.10(b)	Windsurfer	C.6.2(c)
Tack Point	G.4.3	Wing	E.1.2(l)
Three-Quarter Leech Point (trilateral sails)	G.5.3	Wingspan	E.2.2
Three-Quarter Leech Point (other sails)	G.5.3 * ¹	Woven Ply	G.1.4(d)
Three-Quarter Luff Point	G.5.8	Y	
Three-Quarter Width	G.7.6	Yard	F.1.4(d)(v)
		Yaw Rig	F.1.2(e)

*¹ See Section G(B) – Additions for Other Sails

sport / nature / technology



World Sailing

20 Eastbourne Terrace
London, W2 6LG
United Kingdom

Tel: + 44 (0)2039 404 888

www.sailing.org

THE YACHT-MASTER

The emblematic nautical watch embodies a yachting heritage that stretches back to the 1950s.
It doesn't just tell time. It tells history.



OYSTER PERPETUAL YACHT-MASTER 40

ROLEX